

# *AquaMark Booster System*

## **Installation, Operation & Maintenance Manual**

### **Model: AM-LG1.5**

**Electrical Supply: 240Volt 60Hz 1Ph**

## **THIS PUMP MUST BE PRIMED!**

To prime this pump after initial installation you must close the outlet ball valve (to the building). Open the supply-line ball valve. Loosen the vent plug, leave loose until all air escapes and you get a slight amount of water.

### **See Piping Diagram:**

In normal operation a bypass valve should be installed and is to remain closed.

In normal operation the supply valve from the city water main **MUST** remain open.

In normal operation the valve to the building is open.

Yearly inspections should be made to check for leaks or unusual noise and proper maintenance procedures performed if necessary.

# AM-LG1.5 PRESSURE BOOSTER SYSTEM

## Installation & Operation Manual

### Installation:

- If possible leave at least 12" around the pressure booster so the unit can be easily serviced.
- Plumb pressure booster as shown in diagram in this manual.
- Always supply pressure booster with correct size pipe (as noted in manual).
- Install unions on both the inlet and outlet side of the booster. If needed the unit can be removed for service.
- Install vibration isolator on outlet side of pressure booster to eliminate vibration if desired
- Inlet and Outlet of equal size
- Have a licensed electrician run the 240-208 volt 60 Hz 3 Phase 20 AMP power to an electrical box mounted on the wall. This electrical box should be located near the pressure booster, and easily accessible. Connect the 6' cord from the booster to the electrical box.

### Operation:

- Open inlet ball valve.
- Open outlet ball valve.
- Turn On Power
- Pump will turn on and come up to pressure.
- You're done!

### Maintenance:

- This booster has been designed to be maintenance free for many years.
- Do not rest items against switches, gauges, tank drain valves, or pressure relief valve.
- Do not rest items against pumps, the pump is air cooled and needs space to dissipate heat and take in fresh air. Leave at least 12" of space around the pump.
- For parts or questions regarding installation or service of this booster please contact AquaMark Service at:
  - H.O.K. Sales Inc.
  - 
  - Ph 800-323-4498 Fx 888-246-5725

## Submittal Data

AquaMark  
245 W. Roosevelt Rd  
West Chicago, IL 60185  
Ph.# 800-323-4498

Variable Frequency Drive  
Simplex Water Pressure  
Ultra Low Profile  
Booster System

### AquaMark Model# AM-LG1.5

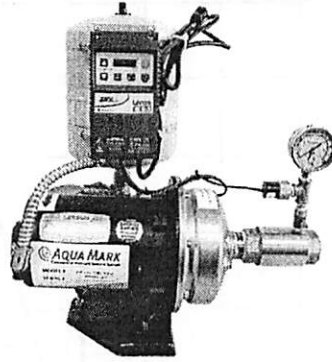

| Dimensions                |        |                 |        |       | Pipe Size                |        |                         |                 |       |
|---------------------------|--------|-----------------|--------|-------|--------------------------|--------|-------------------------|-----------------|-------|
| Model                     | Motor  | Height          | Length | Width | Inlet                    | Outlet | Voltage                 | Hz.             | Phase |
| AM-LG1.5                  | 1.5 HP | 20"             | 19"    | 16"   | 1.5"                     | 1.5"   | 240                     | 60              | 1     |
| Materials of Construction |        |                 |        |       | Operating Conditions     |        |                         |                 |       |
| Description               |        |                 |        |       |                          |        |                         |                 |       |
| Pump Casing               |        | Stainless Steel |        |       | Max. Flow                |        |                         | 50 GPM          |       |
| Impeller                  |        | Stainless Steel |        |       | Max. Press Boost         |        |                         | See Chart Below |       |
| Shaft                     |        | Stainless Steel |        |       | Max. System Press.       |        |                         | 100 PSI         |       |
| Seal                      |        | Type 21         |        |       | Min. Suction Press.      |        |                         | 10 PSI          |       |
| Platform                  |        | Fab. Steel      |        |       | Low Pressure Cut-off     |        |                         | 7 PSI           |       |
| Valves                    |        | Brass           |        |       | VFD Control              |        |                         | Nema1           |       |
| Connection Piping         |        | Brass           |        |       | Supply Line Minimum      |        |                         | See Chart Below |       |
| Diaphragm Tank            |        | Steel           |        |       | Up to a 5 Story Building |        |                         |                 |       |
| Pump:<br>CDU120/3-1.5     |        |                 |        |       | Electrical Connection    |        | 6' Whip to be hardwired |                 |       |

|  |                              |
|--|------------------------------|
| @ 10 GPM 100' Head, 43 PSI Boost Over Incoming |                              |
| @ 15 GPM 98' Head, 42 PSI Boost Over Incoming  |                              |
| @ 25 GPM 92' Head, 39 PSI Boost Over Incoming  | 1 ¼" Supply Line 25 GPM Max. |
| @ 30 GPM 88' Head, 38 PSI Boost Over Incoming  | 1 ½" Supply Line 38 GPM Max. |
| @ 50 GPM 72' Head, 31 PSI Boost Over Incoming  | 2" Supply Required           |

A Larger Tank Can Be Installed After The Booster For Longer Shutdown Periods During Low Flows.

Model CDU

EBARA Stainless Steel Centrifugal Pumps

Performance Curves

CDU120/3-1 1/2 HP

Synchronous Speed: 3450 RPM

Size: 1 x 1 1/4 x 5 3/16

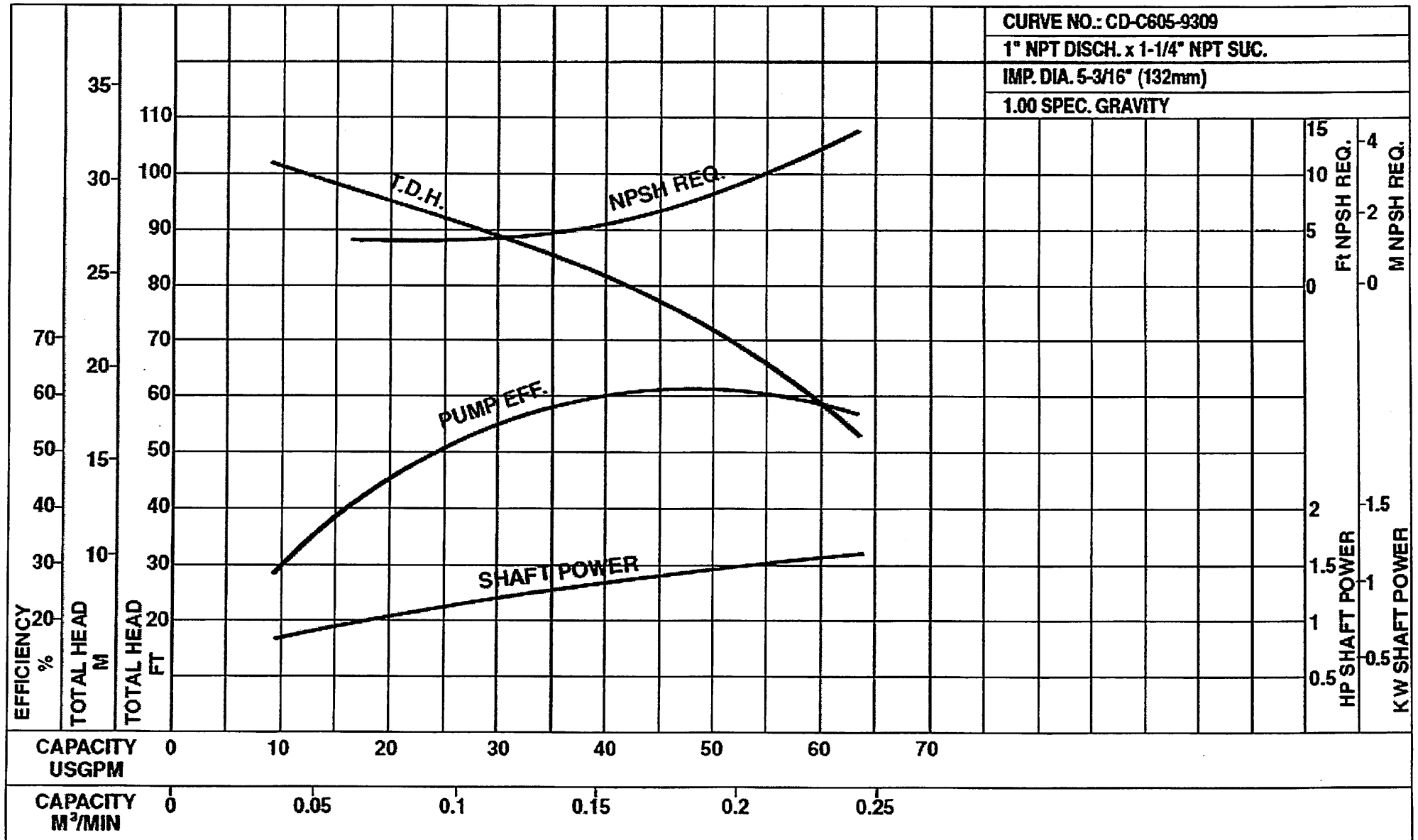

## THIS PUMP MUST BE PRIMED!

Open the city water supply valve to the booster. Open the discharge valve from the pressure booster system that supplies water to the building. Run water in the building for a minute. This will force water into the pump housing from the city. The pump will be primed.

- We recommend a bypass valve configuration be installed on ALL booster pump installations.
- In normal operation the bypass valve should be in the closed position.
- In normal operation the supply line valve from the city water main MUST remain open.
- In normal operation the discharge valve to the building from the booster should be open.
- There is a relief valve included and installed on this AquaMark pressure booster system. This relief valve discharge shall be piped to a floor drain.
- Yearly inspections should be made to check for leaks or unusual noise and proper maintenance procedures performed if necessary.

**Relief valve discharge outlet shall be piped to floor drain. Follow local codes pertaining to relief valve piping and drainage.**

# Installation

- Leave 12" of clear space around the pressure booster to allow for service work to be performed as necessary in the future.
- Plumb pressure booster as shown in the diagram included in this manual.
- Supply pressure booster with correct incoming minimum supply line size (or greater) as noted on the first page of this manual.
- Plumb a three valve bypass system during installation of this pressure booster. When service needs to be performed this will allow normal city water pressure to be supplied to the building while servicing/repairing the pressure booster system.
- Unions are recommended when installing this pressure booster system.
- Optional accessories include anti-vibration mat, vibration isolator and diaphragm type tank to be installed after the booster system (the tank will allow for extended shut down periods during low flow demands).
- Have your electrician supply this pressure booster with a dedicated circuit.

# Operation

- Make sure valve from city water supply to the pressure booster is in the full open position.
- Make sure valve on the discharge side of the pressure booster is in the full open position.
- Make sure that the bypass valve line is in the full closed position (if the bypass valve is in the open position the pressure booster will not shut off).
- Supply electrical power to the pressure booster by switching the wall mounted cut-off switch to the on position.
- Pressure booster will turn on and boost pressure to the desired set-point. Pressure booster will continue to run until the demand has been met. Pressure booster will enter sleep mode after demand has been met and a pre-determined amount of time has passed.

# Maintenance

- This pressure booster has been designed to be maintenance free for many years.
- Do not rest items against switches, gauges, tank drain valves, or pressure relief valve.
- Do not rest items against pump. The pump requires free air space surrounding it to dissipate heat and take in fresh air for cooling purposes. Leave 12" of free air space all around the system.

**In Bypass Position**

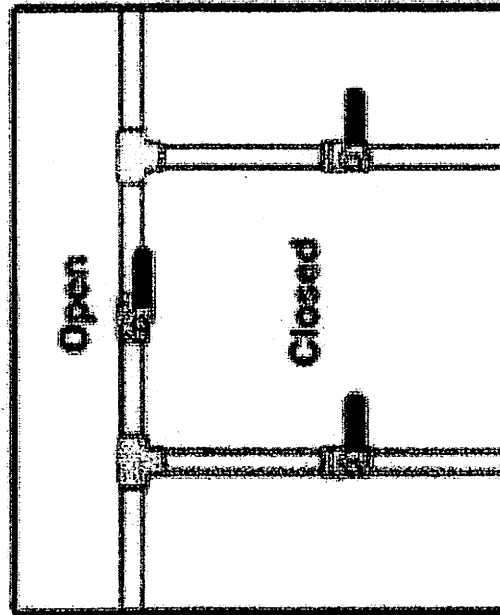

**In Service Position**

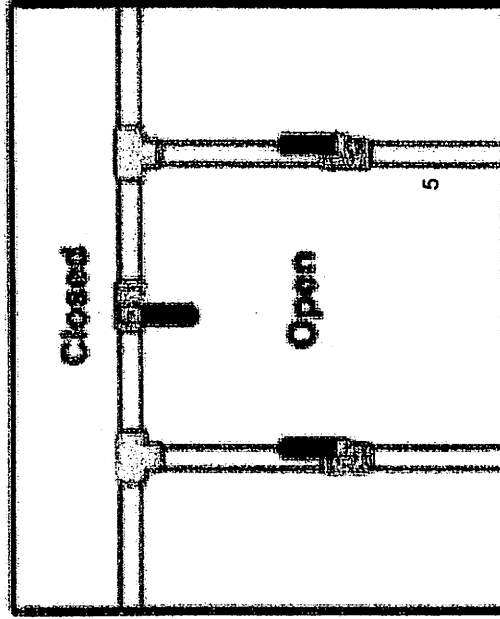



## Submittal Data

AquaMark  
 245 W. Roosevelt Rd  
 Building 12, Suite 83  
 West Chicago, IL 60185  
 Ph.# 800-323-4498

### Variable Frequency Drive

Simplex Water Pressure  
 Ultra Low Profile  
 Booster System

### AquaMark Model# AM-LG

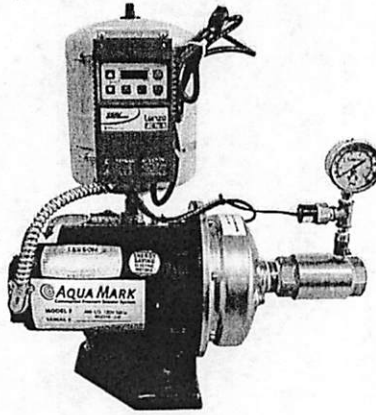

| Dimensions                |       |                 |        | Pipe Size |                          |        |                 |     |       |
|---------------------------|-------|-----------------|--------|-----------|--------------------------|--------|-----------------|-----|-------|
| Model                     | Motor | Height          | Length | Width     | Inlet                    | Outlet | Voltage         | HZ. | Phase |
| AM-LG                     | 1 HP  | 20"             | 19"    | 16"       | 1 1/4"                   | 1 1/4" | 120             | 60  | 1     |
|                           |       |                 |        |           |                          |        | 240             | 60  | 1     |
| Materials of Construction |       |                 |        |           | Operating Conditions     |        |                 |     |       |
| Description               |       |                 |        |           |                          |        |                 |     |       |
| Pump Casing               |       | Stainless Steel |        |           | Max. Flow                |        | 50 GPM          |     |       |
| Impeller                  |       | Stainless Steel |        |           | Max. Press Boost         |        | See Chart Below |     |       |
| Shaft                     |       | Stainless Steel |        |           | Max. System Press.       |        | 95 PSI          |     |       |
| Seal                      |       | Type 21         |        |           | Min. Suction Press.      |        | 10 PSI          |     |       |
| Platform                  |       | Fab. Steel      |        |           | Low Pressure Cut-off     |        | 7 PSI           |     |       |
| Valves                    |       | Brass           |        |           | VFD Control              |        | Nema1           |     |       |
| Connection Piping         |       | Brass           |        |           | Supply Line Minimum      |        | 1 1/4"          |     |       |
| Diaphragm Tank            |       | Steel           |        |           | Up to a 2 Story Building |        |                 |     |       |
| Motor                     |       | ODP             |        |           |                          |        |                 |     |       |

|  |  |
|--|--|
|  | An additional tank may be installed after the booster for longer shut down periods during low flows. |
| 31 PSI Boost @ 15 GPM 72' Head                             |  |
| 30 PSI Boost @ 20 GPM 75' Head                             |  |
| 28 PSI Boost @ 30 GPM 65' Head 1 1/2" Supply Line Required |  |
| 20 PSI Boost @ 50 GPM 45' Head 2" Supply Line Required     | <b>TWO YEAR WARRANTY</b>   |

**EBARA**

# Model 3U/CDU

end suction centrifugal

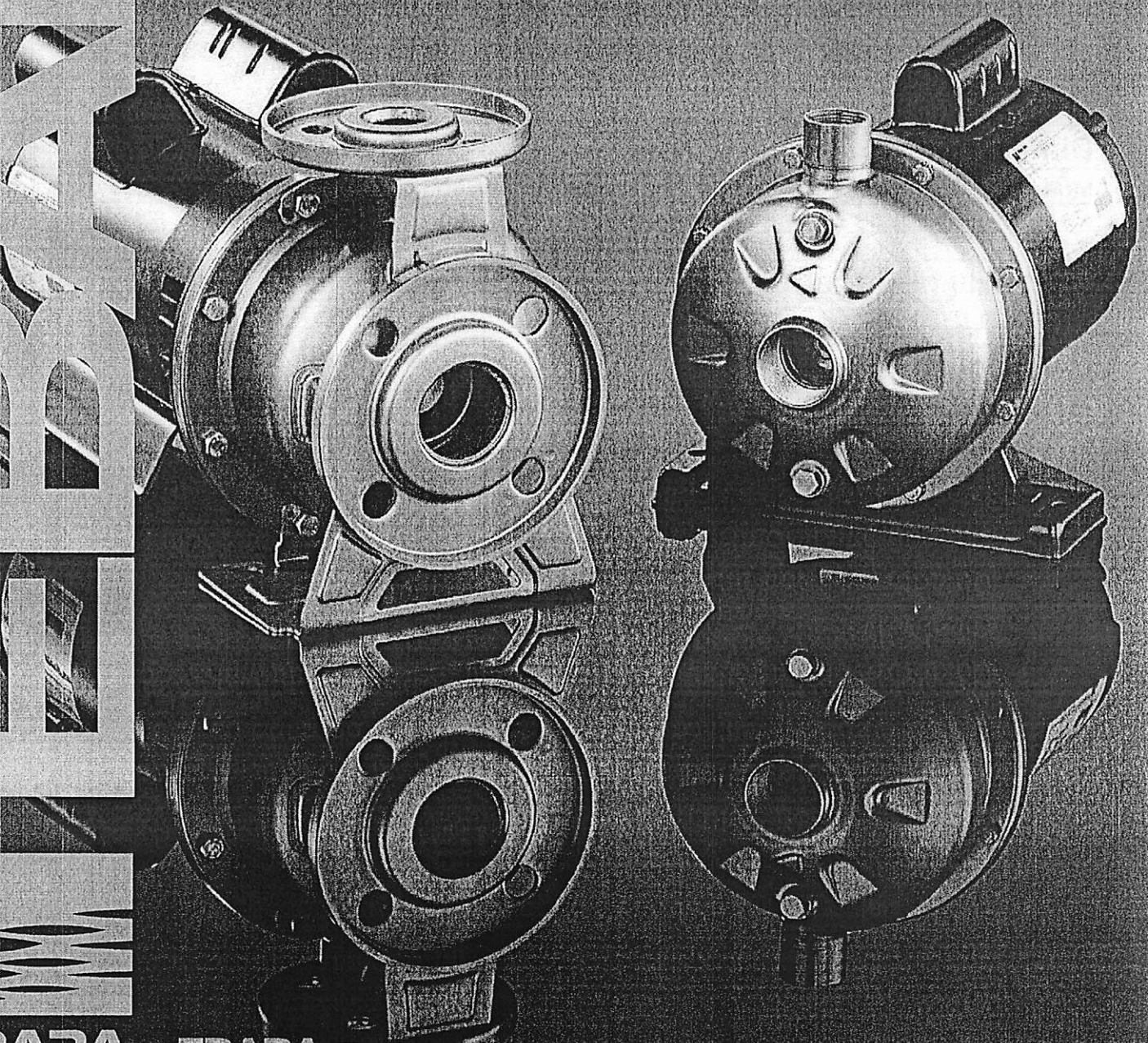

**EBARA**

**EBARA** Fluid Handling

*an EBARA International Corporation company*

# Model 3U/CDU

## Features

- **Close coupled design**
  - saves space; simplifies maintenance and installation
- **Stainless steel liquid end components**
  - high quality; corrosion resistance
- **Versatile mounting**
  - can be installed horizontally or vertically
- **Back pullout construction**
  - assembly and overhaul of the impeller and seal without disturbing suction and discharge connections
- **Top centerline discharge and foot support under casing**
  - ensures self-venting and reduces misalignment from pipe loads
- **High operating efficiency**
  - lowers operating costs
- **High quality mechanical shaft seals and o-rings**
  - available for standard pumping requirements or optional high temperature and chemical duty operation



\*Note: NSF/ANSI 61 Annex G listed

Compliant to NSF/ANSI 61 Annex G

## Applications

- Plant services
- Water supply systems
- Washing plants
- Cooling water
- Car wash
- Scrubbers
- Ultrapure water systems
- Jockey pump services
- Air conditioning
- Sprinkler/flow irrigation
- OEM equipment application
- Pressure boosting
- Liquid transfer
- Heat exchanger
- Spray systems
- Heating
- Beverage processing
- Pharmaceutical services
- Water reclamation and treatment
- General pump applications

## 3U selection chart

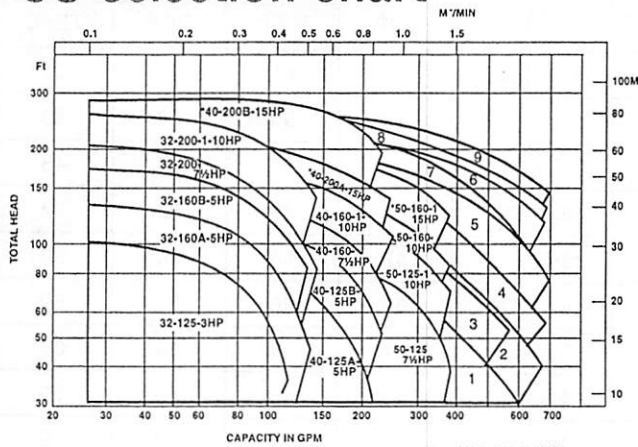

\*Three phase motor only

1. 3U65-125-7.5HP
2. 3U65-125-10HP
3. 3U65-160-10HP
4. 3U65-160-15HP\*
5. 3U65-160-20HP\*
6. 3U65-160-25HP\*
7. 3U65-200-20HP\*
8. 3U65-200-25HP\*
9. 3U65-200-30HP\*

\*Note: Model 3U-65 – standard bronze impeller; optional SS impellers available

## CDU selection chart

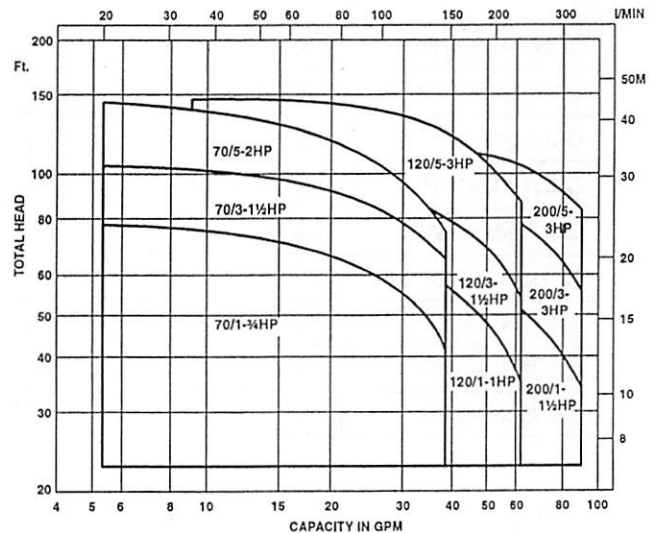

### EBARA Fluid Handling

1651 Cedar Line Drive • Rock Hill, SC 29730 • (t) 803 327 5005 • (f) 803 327 5097

www.pumpsebara.com

©2006 EBARA International Corporation

EFHCD@3U0312

**Model CDU  
Pump Dimensions**

**EBARA Stainless Steel Centrifugal Pumps**

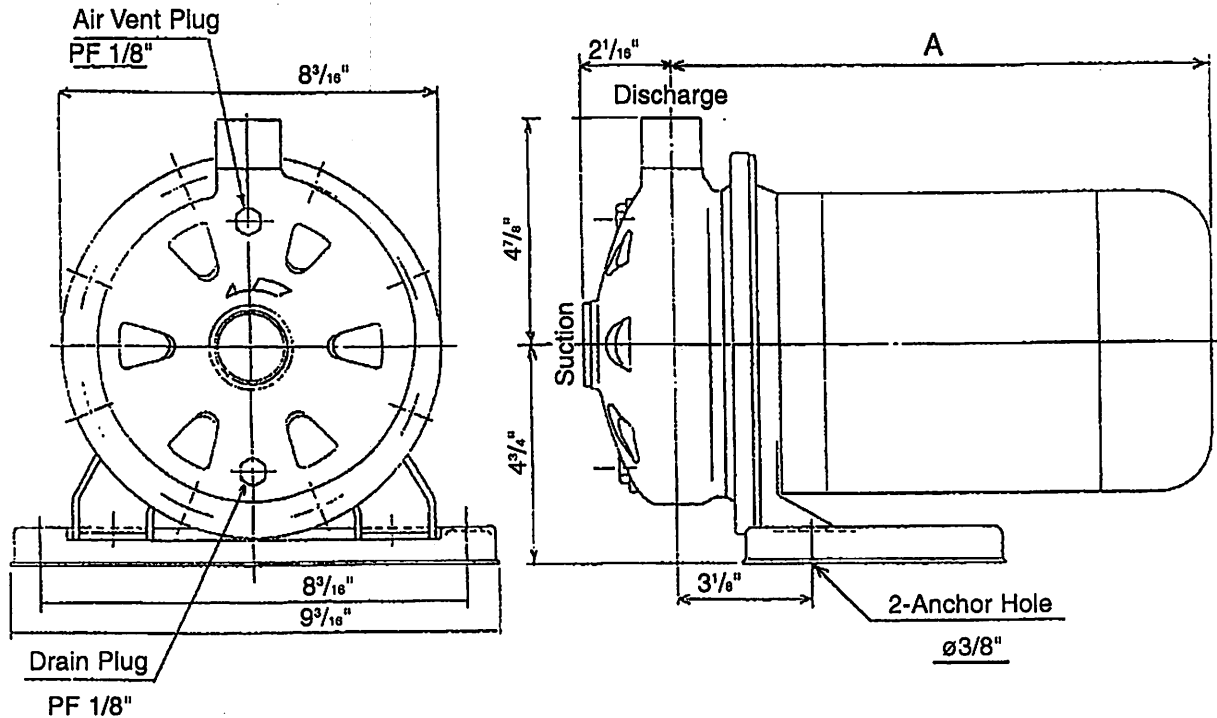

| Model                                     | Model   | Pump Size – NPT (Inch)        |           | Dimension (Inch)<br>A                | Unit Weight (lbs.) |     |             |    |
|---|---|-------------------------------|-----------|--------------------------------------|--------------------|-----|-------------|----|
|   |   | Suction                       | Discharge |                                      | Single Phase       |     | Three Phase |    |
|   |   |                               |           | ODP                                  | TEFC               | ODP | TEFC        |    |
| CDU70/1-3/4HP                             | 1 x 1 <sup>1</sup> / <sub>4</sub> x 4 <sup>1</sup> / <sub>2</sub>   | 1 <sup>1</sup> / <sub>4</sub> | 1         | 13 <sup>7</sup> / <sub>16</sub> Max. | 36                 | 41  | 31          | 31 |
| CDU70/3-1 <sup>1</sup> / <sub>2</sub> HP  | 1 x 1 <sup>1</sup> / <sub>4</sub> x 5 <sup>9</sup> / <sub>16</sub>  | 1 <sup>1</sup> / <sub>4</sub> | 1         | 13 <sup>9</sup> / <sub>16</sub> Max. | 47                 | 50  | 39          | 39 |
| CDU70/5-2HP                               | 1 x 1 <sup>1</sup> / <sub>4</sub> x 6 <sup>9</sup> / <sub>16</sub>  | 1 <sup>1</sup> / <sub>4</sub> | 1         | 14 <sup>7</sup> / <sub>16</sub> Max. | 51                 | 58  | 44          | 48 |
| CDU120/1-1HP                              | 1 x 1 <sup>1</sup> / <sub>4</sub> x 4 <sup>1</sup> / <sub>2</sub>   | 1 <sup>1</sup> / <sub>4</sub> | 1         | 13 <sup>9</sup> / <sub>16</sub> Max. | 41                 | 46  | 33          | 32 |
| CDU120/3-1 <sup>1</sup> / <sub>2</sub> HP | 1 x 1 <sup>1</sup> / <sub>4</sub> x 5 <sup>9</sup> / <sub>16</sub>  | 1 <sup>1</sup> / <sub>4</sub> | 1         | 13 <sup>9</sup> / <sub>16</sub> Max. | 47                 | 50  | 39          | 39 |
| CDU120/5-3HP                              | 1 x 1 <sup>1</sup> / <sub>4</sub> x 6 <sup>9</sup> / <sub>16</sub>  | 1 <sup>1</sup> / <sub>4</sub> | 1         | 14 <sup>7</sup> / <sub>16</sub> Max. | 59                 | 66  | 51          | 60 |
| CDU200/1-1 <sup>1</sup> / <sub>2</sub> HP | 1 x 1 <sup>1</sup> / <sub>2</sub> x 4 <sup>1</sup> / <sub>2</sub>   | 1 <sup>1</sup> / <sub>2</sub> | 1         | 13 <sup>9</sup> / <sub>16</sub> Max. | 47                 | 50  | 39          | 39 |
| CDU200/3-3HP                              | 1 x 1 <sup>1</sup> / <sub>2</sub> x 5 <sup>9</sup> / <sub>16</sub>  | 1 <sup>1</sup> / <sub>2</sub> | 1         | 14 <sup>7</sup> / <sub>16</sub> Max. | 58                 | 65  | 50          | 59 |
| CDU200/5-3HP                              | 1 x 1 <sup>1</sup> / <sub>2</sub> x 5 <sup>11</sup> / <sub>16</sub> | 1 <sup>1</sup> / <sub>2</sub> | 1         | 14 <sup>7</sup> / <sub>16</sub> Max. | 58                 | 65  | 50          | 59 |

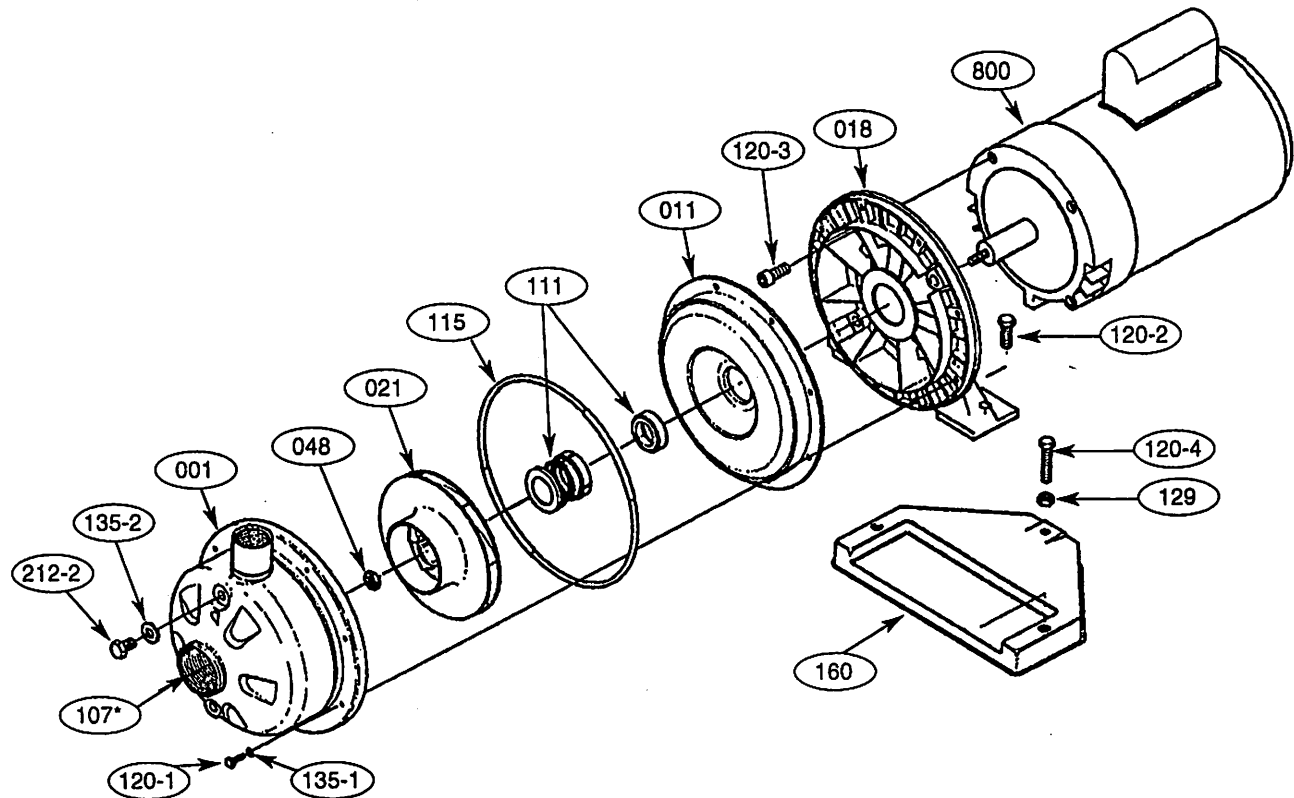

| Part No. | Part Name                         | Material       | No. for 1 Unit |
|----------|-----------------------------------|----------------|----------------|
| 001      | Casing                            | 304L Stainless | 1              |
| 011      | Casing cover                      | 304L Stainless | 1              |
| 018      | Bracket                           | Aluminum       | 1              |
| 021      | Impeller                          | 304L Stainless | 1              |
| 048      | Impeller nut                      | 304L Stainless | 1              |
| 107*     | Casing ring (*CDU 70 series only) | Viton          | 1              |
| 111      | Mechanical seal                   | —              | 1              |
| 115      | O-Ring                            | Viton          | 1              |
| 120-1    | Bolt                              | 304L Stainless | 8              |
| 120-2    | Bolt                              | 304L Stainless | 2              |
| 120-3    | Bolt                              | 304L Stainless | 4              |
| 120-4    | Bolt                              | 304L Stainless | 1              |
| 129      | Nut                               | 304L Stainless | 1              |
| 135-1    | Washer                            | 304L Stainless | 8              |
| 135-2    | Washer                            | Aluminum       | 2              |
| 160      | Base                              | Steel          | 1              |
| 212-2    | Plug                              | 304L Stainless | 2              |
| 800      | Motor                             | —              | 1              |



**SMV**

Frequency Inverter

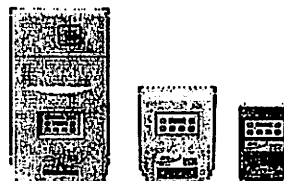

Operating instructions EN



**Lenze**

**Copyright © 2013 - 2006 Lenze AC Tech Corporation**

All rights reserved. No part of this manual may be reproduced or transmitted in any form without written permission from Lenze AC Tech Corporation. The information and technical data in this manual are subject to change without notice. Lenze AC Tech Corporation makes no warranty of any kind with respect to this material, including, but not limited to, the implied warranties of its merchantability and fitness for a given purpose. Lenze AC Tech Corporation assumes no responsibility for any errors that may appear in this manual.

All information given in this documentation has been carefully selected and tested for compliance with the hardware and software described. Nevertheless, discrepancies cannot be ruled out. We do not accept any responsibility nor liability for damages that may occur. Any necessary corrections will be implemented in subsequent editions.

This document printed in the United States

## Contents

|   |           |
|---|-----------|
| About these Instructions .....                                  | 2         |
| <b>1 Safety Information .....</b>                               | <b>3</b>  |
| <b>2 Technical Data .....</b>                                   | <b>7</b>  |
| 2.1 Standards and Application Conditions .....                  | 7         |
| 2.2 SMV Type Number Designation .....                           | 8         |
| 2.3 Ratings .....   | 9         |
| <b>3 Installation .....</b>                                     | <b>12</b> |
| 3.1 Dimensions and Mounting .....                               | 12        |
| 3.1.1 NEMA 1 (IP31) Models ≤ 30HP (22kW) .....                  | 12        |
| 3.1.2 NEMA 1 (IP31) Models > 30HP (22kW) .....                  | 13        |
| 3.1.3 NEMA 4X (IP65) Models .....                               | 14        |
| 3.1.4 NEMA 4X (IP65) Models with Disconnect Switch .....        | 15        |
| 3.2 Electrical Installation .....                               | 16        |
| 3.2.1 Power Connections .....                                   | 16        |
| 3.2.1.1 Mains Connection to 120VAC Single-Phase Supply .....    | 16        |
| 3.2.1.2 Mains Connection to 240VAC Single-Phase Supply .....    | 17        |
| 3.2.1.3 Mains Connection to Three-Phase Supply .....            | 17        |
| 3.2.1.4 Motor Connection .....                                  | 17        |
| 3.2.1.5 Installation Recommendations for EMC Compliance .....   | 18        |
| 3.2.1.6 NEMA 4X (IP65) Input Terminal Block .....               | 18        |
| 3.2.1.7 Dynamic Brake Connections .....                         | 19        |
| 3.2.2 Fuses/Cable Cross-Sections .....                          | 20        |
| 3.2.3 Control Terminals .....                                   | 21        |
| <b>4 Commissioning .....</b>                                    | <b>23</b> |
| 4.1 Local Keypad & Display .....                                | 23        |
| 4.2 Drive Display and Modes of Operation .....                  | 25        |
| 4.3 Parameter Setting .....                                     | 26        |
| 4.4 Electronic Programming Module (EPM) .....                   | 26        |
| 4.5 Parameter Menu .....  | 27        |
| 4.5.1 Basic Setup Parameters .....                              | 27        |
| 4.5.2 I/O Setup Parameters .....                                | 31        |
| 4.5.3 Advanced Setup Parameters .....                           | 35        |
| 4.5.4 PID Parameters .....                                      | 39        |
| 4.5.5 Vector Parameters .....                                   | 41        |
| 4.5.6 Network Parameters .....                                  | 43        |
| 4.5.7 Diagnostic Parameters .....                               | 44        |
| 4.5.7.1 Terminal & Protection Status Display .....              | 45        |
| 4.5.7.2 Keypad Status Display .....                             | 45        |
| 4.5.8 Onboard Communications Parameters 15-60HP (11-45kW) ..... | 46        |
| 4.5.9 Sequencer Parameters .....                                | 47        |
| 4.5.9.1 Sequencer Flow Diagram Left .....                       | 55        |
| 4.5.9.2 Sequencer Flow Diagram Right .....                      | 56        |
| 4.5.9.3 Sequencer Status .....                                  | 57        |
| <b>5 Troubleshooting and Diagnostics .....</b>                  | <b>58</b> |
| 5.1 Status/Warning Messages .....                               | 58        |
| 5.2 Drive Configuration Messages .....                          | 59        |
| 5.3 Fault Messages .....  | 59        |
| <b>Appendix A .....</b>   | <b>62</b> |
| A.1 Permissible Cable Lengths .....                             | 62        |





## About These Instructions

This documentation applies to the SMV frequency inverter and contains important technical data regarding the installation, operation, and commissioning of the inverter.

These instructions are only valid for SMV frequency inverters with software revision 4.23 or higher for version 4.23 software, the drive nameplate illustrated below would show "42" in the "F" location.

Please read these instructions in their entirety before commissioning the drive.

|   |   |   |   |   |   |
|---|---|---|---|---|---|
| A | B | C | D | E | F |
|   |   |   |   |   |   |

| A              | B    | C             | D              | E                | F                |
|----------------|------|---------------|----------------|------------------|------------------|
| Certifications | Type | Input Ratings | Output Ratings | Hardware Version | Software Version |

| Scope of delivery  | Important  |
|--|--|
| <ul style="list-style-type: none"> <li>1 SMV Inverter with EPM installed (see Section 4.4)</li> <li>1 Operating instructions manual</li> </ul> | <p>After receipt of the delivery, check immediately whether the items delivered match the accompanying papers. Lenze AC Tech does not accept any liability for deficiencies claimed subsequently.</p> <p>Claim:</p> <ul style="list-style-type: none"> <li>visible transport damage immediately to the forwarder.</li> <li>visible deficiencies/incompleteness immediately to your Lenze AC Tech representative</li> </ul> |

### Related Documents

The documentation listed herein contains information relevant to the operation of the SMVector frequency inverter. To obtain the latest documentation, visit the Technical Library at <http://www.lenzeamericas.com>.

| Document # | Description  |
|------------|--|
| CMVINS01   | SMVector Communications Module Installation Instruction              |
| CMVMB401   | SMVector ModBus RTU over RS485 Communications Reference Guide        |
| CMVLC401   | SMVector Lecom Communications Reference Guide                        |
| CMVCAN01   | SMVector CANopen Communications Reference Guide                      |
| CMVDVN01   | SMVector DeviceNet Communications Reference Guide                    |
| CMVETH01   | SMVector EtherNet/IP Communications Reference Guide                  |
| CMVPPB01   | SMVector PROFIBUS Communications Reference Guide                     |
| ALSV01     | SMVector Additional I/O Module Installation and Operation Manual     |
| DBV01      | SMVector Dynamic Braking   |
| PTV01      | SMVector Potentiometer Install Instructions                          |
| RKV01      | SMVector ESVZXK1 Remote Keypad                                       |
| RKVU01     | SMVector ESVZXH0 Remote Keypad (for NEMA 1 15-60HP (11-45kW) Drives) |

# 1 Safety Information

## General

Some parts of Lenze AC Tech controllers can be electrically live and some surfaces can be hot. Non-authorized removal of the required cover, inappropriate use, and incorrect installation or operation creates the risk of severe injury to personnel and/or damage to equipment.

All operations concerning transport, installation, and commissioning as well as maintenance must be carried out by qualified, skilled personnel who are familiar with the installation, assembly, commissioning, and operation of variable frequency drives and the application for which it is being used.

## Installation

Ensure proper handling and avoid excessive mechanical stress. Do not bend any components and do not change any insulation distances during transport, handling, installation or maintenance. Do not touch any electronic components or contacts. This drive contains electrostatically sensitive components, which can easily be damaged by inappropriate handling. Static control precautions must be adhered to during installation, testing, servicing and repairing of this drive and associated options. Component damage may result if proper procedures are not followed.

To ensure proper operation, do not install the drive where it is subjected to adverse environmental conditions such as combustible, oily, or hazardous vapors; corrosive chemicals; excessive dust, moisture or vibration; direct sunlight or extreme temperatures.

This drive has been tested by Underwriters Laboratory (UL) and is UL Listed in compliance with the UL508C Safety Standard. This drive must be installed and configured in accordance with both national and international standards. Local codes and regulations take precedence over recommendations provided in this and other Lenze AC Tech documentation.

The SMVector drive is considered a component for integration into a machine or process. It is neither a machine nor a device ready for use in accordance with European directives (reference machinery directive and electromagnetic compatibility directive). It is the responsibility of the end user to ensure that the machine meets the applicable standards.

## Electrical Connection

When working on live drive controllers, applicable national safety regulations must be observed. The electrical installation must be carried out according to the appropriate regulations (e.g. cable cross-sections, fuses, protective earth [PE] connection). While this document does make recommendations in regards to these items, national and local codes must be adhered to.

The documentation contains information about installation in compliance with EMC (shielding, grounding, filters and cables). These notes must also be observed for CE-marked controllers. The manufacturer of the system or machine is responsible for compliance with the required limit values demanded by EMC legislation.

## Application

The drive must not be used as a safety device for machines where there is a risk of personal injury or material damage. Emergency Stops, over-speed protection, acceleration and deceleration limits, etc must be made by other devices to ensure operation under all conditions.

The drive does feature many protection devices that work to protect the drive and the driven equipment by generating a fault and shutting the drive and motor down. Mains power variances can also result in shutdown of the drive. When the fault condition disappears or is cleared, the drive can be configured to automatically restart, it is the responsibility of the user, OEM and/or integrator to ensure that the drive is configured for safe operation.



## Safety Information

### Explosion Proof Applications

Explosion proof motors that are not rated for inverter use lose their certification when used for variable speed. Due to the many areas of liability that may be encountered when dealing with these applications, the following statement of policy applies:

Lenze AC Tech Corporation inverter products are sold with no warranty of fitness for a particular purpose or warranty of suitability for use with explosion proof motors. Lenze AC Tech Corporation accepts no responsibility for any direct, incidental or consequential loss, cost or damage that may arise through the use of AC inverter products in these applications. The purchaser expressly agrees to assume all risk of any loss, cost or damage that may arise from such application.

### Operation

Systems including controllers must be equipped with additional monitoring and protection devices according to the corresponding standards (e.g. technical equipment, regulations for prevention of accidents, etc.). The controller may be adapted to your application as described in this documentation.



#### DANGER!

- After the controller has been disconnected from the supply voltage, live components and power connection must not be touched immediately, since capacitors could be charged. Please observe the corresponding notes on the controller.
- Close all protective covers and doors prior to and during operation.
- Do not cycle input power to the controller more than once every two minutes.
- For SMVector models that are equipped with a Disconnect Switch (11th character in model number is L or M), the Disconnect Switch is intended as a motor service disconnect and does not provide branch circuit protection to the inverter or motor. When servicing the motor, it is necessary to wait 3 minutes after turning this switch to the off position before working on motor power wiring as the inverter stores electrical power. To service the inverter, it is necessary to remove mains ahead of the drive and wait 3 minutes.

### Safety Notifications

All safety information given in these Operating Instructions includes a visual icon, a bold signal word and a description.



**Signal Word!** (characterizes the severity of the danger)

**NOTE** (describes the danger and informs on how to proceed)

| Icon | Signal Word                           | Meaning  | Consequences if Ignored   |
|------|---------------------------------------|--|---|
|      | <b>DANGER!</b>                        | Warns of hazardous electrical voltage.   | Death or severe injuries.   |
|      | <b>WARNING!</b>                       | Warns of potential, very hazardous situations.   | Risk of severe injury to personnel and/or damage to equipment.            |
|      | <b>WARNING!</b><br><b>Hot Surface</b> | Warns of hot surface and risk of burns. Labels may be on or inside the equipment to alert people that surfaces may reach dangerous temperatures. | Risk of severe injury to personnel.                                       |
|      | <b>STOP!</b>                          | Warns of potential damage to material and equipment.   | Damage to the controller/drive or its environment.                        |
|      | <b>NOTE</b>                           | Designates a general, useful note.   | None. If observed, then using the controller/drive system is made easier. |

## Safety Information



### Harmonics Notification in accordance with EN 61000-3-2, EN 61000-3-12:

Operation in public supply networks (Limitation of harmonic currents i.a.w. EN 61000-3-2, Electromagnetic Compatibility (EMC) Limits). Limits for harmonic current emissions (equipment input current up to 16A/phase).

| Directive     | Total Power connected to Mains (public supply) | Additional Measures Required for Compliance <sup>(1)</sup>        |
|---------------|--|---|
| EN 61000-3-2  | < 0.5kW  | with mains choke  |
|               | 0.5 ... 1kW                                    | with active filter  |
|               | > 1kW  | complies without additional measures                              |
| EN 61000-3-12 | 16 ... 75amp                                   | Additional measures are required for compliance with the standard |

(1) For compliance with EMC regulations, the permissible cable lengths may change.

(2) The additional measures described only ensure that the controller meets the requirements of the EN 61000-3-2. The machine/system manufacturer is responsible for the machine's compliance with the regulations.

### Safety Information in accordance with EN 61800-5-1:



#### DANGER! - Risk of Electric Shock

Capacitors retain charge for approximately 180 seconds after power is removed. Disconnect incoming power and wait at least 3 minutes before touching the drive.

#### DANGER! - Risque de choc électrique

Les condensateurs restent sous charge pendant environ 180 secondes après une coupure de courant. Couper l'alimentation et patienter pendant au moins 3 minutes avant de toucher l'entraînement.



#### WARNING!

- This product can cause a d.c. current in the PE conductor. Where a residual current-operated (RCD) or monitoring (RCM) device is used for protection in case of direct or indirect contact, only an RCD or RCM Type B is allowed on the supply side of this product.
- Leakage Current may exceed 3.5mA AC. The minimum size of the PE conductor shall comply with local safety regulations for high leakage current equipment.
- In a domestic environment, this product may cause radio interference in which case supplementary mitigation measures may be required.



## Safety Information

### Safety Information in accordance with UL:

Note for UL approved system with integrated controllers: UL warnings are notes which apply to UL systems. The documentation contains special information about UL.



- Integral solid state protection does not provide branch circuit protection. Branch circuit protection must be provided in accordance with the National Electrical Code and any additional local codes. The use of fuses or circuit breakers is the only approved means for branch circuit protection.
- When protected by CC and T Class Fuses, suitable for use on a circuit capable of delivering not more than 200,000 rms symmetrical amperes, at the maximum voltage rating marked on the drive.
- Additionally suitable when protected by a circuit breaker having an interrupting rating not less than 200,000 rms symmetrical amperes, at the maximum voltage rating marked on the drive. (Excludes ESV113xx2T, ESV153xx2T, ESV113xx4T, ESV153xx4T, ESV183xx4T, ESV223xx4T, ESV303xx4T, ESV113xx6T, ESV153xx6T, ESV183xx6T, ESV223xx6T, and ESV303xx6T).
- Use minimum 75°C copper wire only, except for control circuits.
- For control circuits, use wiring suitable for NEC Class 1 circuits only.
- Torque Requirements (in accordance with UL) are listed in section 3.2.1, Power Connections and in 3.2.3, Control terminals
- Shall be installed in a pollution degree 2 macro-environment.
- NEMA 1 (IP31) models shall be installed in a pollution degree 2 macro-environment.
- All models are suitable for installation in a compartment handling Conditioned Air (i.e., plenum rated).



#### WARNING!

The opening of branch-circuit protective device may be an indication that a fault has been interrupted. To reduce the risk of fire or electric shock, current carrying parts and other components of the controller should be examined and replaced if damaged.



#### AVERTISSEMENT!

Le déclenchement du dispositif de protection du circuit de dérivation peut être dû à une coupure qui résulte d'un courant de défaut. Pour limiter le risque d'incendie ou de choc électrique, examiner les pièces porteuses de courant et les autres éléments du contrôleur et les remplacer s'ils sont endommagés. En cas de grillage de l'élément traversé par le courant dans un relais de surcharge, le relais tout entier doit être remplacé.



#### NOTE

Control and communications terminals provide reinforced insulation (i.e. considered SELV or PELV, providing protection in case of direct contact) when the drive is connected to a power system rated up to 300VAC between phase to ground (PE) and the applied voltage on Terminals 16 and 17 is less than 150VAC between phase to ground. Otherwise, control and communications terminals provide basic insulation.

## Technical Data



## 2 Technical Data

### 2.1 Standards and Application Conditions

|   |  |   |
|---|--|---|
| Conformity  | CE   | Low Voltage (2006/95/EC) & EMC (2004/108/EC) Directives   |
| Approvals   | UL508C   | Underwriters Laboratories -Power Conversion Equipment   |
| Input voltage phase imbalance   | ≤ 2%   |   |
| Supported Power Systems   | TT<br>TN   | <ul style="list-style-type: none"> <li>- For central grounded systems, operation is permitted without restrictions.</li> <li>- For corner grounded 400/500V systems, operation is possible but reinforced insulation to control circuits is compromised.</li> </ul> |
| Humidity  | ≤ 95% non-condensing   |   |
| Temperature range   | Transport  | -25 ... +70°C   |
|   | Storage  | -20 ... +70°C   |
|   | Operation  | -10 ... +55°C (with 2.5%/°C current derating above +40°C)   |
| Installation height   | 0 - 4000m a.m.s.l. (with 5%/1000 m current derating above 1000m a.m.s.l.)  |   |
| Vibration resistance  | acceleration resistant up to 1.0g  |   |
|  Earth leakage current | > 3.5 mA to PE   |   |
| Max Permissible Cable Length <sup>(1)</sup>   | ≤ 4.0 Hp (3.0 kW)  | 30 meters shielded, 60 meters un-shielded   |
|   | ⇒ 5.0 Hp (3.7 kW)  | 50 meters shielded, 100 meters un-shielded.   |
| Enclosure   | IP31/NEMA 1  | IP65/NEMA 4X  |
|   | NEMA 1 and NEMA 4X model enclosures are plenum rated in accordance with UL 508C and are suitable for installation in a compartment handling conditioned air.     |   |
| Protection measures against   | Earth fault, phase loss, over voltage, under voltage, motor stalling, over temperature motor overload (125% of FLA), short circuit (SCCR=200kA at rated voltage) |   |
| Compliance with EN 61000-3-2 Requirements <sup>(2)</sup>  | < 0.5kW  | with mains choke  |
|   | 0.5 ... 1kW  | with active filter  |
|   | > 1kW  | without additional measures   |
| Compliance with EN 61000-3-12 Requirements <sup>(2)</sup>   | 16 ... 75amp   | Additional measures required for compliance with EN 61000-3-12  |

Operation in public supply networks (Limitation of harmonic currents i.a.w. EN 61000-3-2, Electromagnetic Compatibility (EMC) Limits). Limits for harmonic current emissions (equipment input current up to 16A/phase).

(1) The stated cable lengths are permissible at default carrier frequencies (refer to parameter P166).

(2) The additional measures described only ensure that the controller meets the requirements of the EN 61000-3-2. The machine/system manufacturer is responsible for the machine's compliance with the regulations.



## Technical Data

### 2.2 SMV Type Number Designation

The table herein describes the Type numbering designation for the SMVector Inverter models.

|   | ESV | 152                    | NO | 2 | T | X | B |
|---|-----|------------------------|----|---|---|---|---|
| Electrical Products in the SMVector Series  |     |                        |    |   |   |   |   |
| <b>Power Rating in kW:</b>  |     |                        |    |   |   |   |   |
| 251 = 0.25kW (0.33HP)   |     | 113 = 11.0kW (15HP)    |    |   |   |   |   |
| 371 = 0.37kW (0.5HP)  |     | 153 = 15.0kW (20HP)    |    |   |   |   |   |
| 751 = 0.75kW (1HP)  |     | 183 = 18.5kW (25HP)    |    |   |   |   |   |
| 112 = 1.1kW (1.5HP)   |     | 223 = 22.0kW (30HP)    |    |   |   |   |   |
| 152 = 1.5kW (2HP)   |     | 303 = 30.0kW (40HP)    |    |   |   |   |   |
| 222 = 2.2kW (3HP)   |     | 373 = 37.5kW (50HP)    |    |   |   |   |   |
| 302 = 3.0kW (4HP)   |     | 453 = 45.0kW (60HP)    |    |   |   |   |   |
| 402 = 4.0kW (5HP)   |     |                        |    |   |   |   |   |
| 552 = 5.5kW (7.5HP)   |     |                        |    |   |   |   |   |
| 752 = 7.5kW (10HP)  |     |                        |    |   |   |   |   |
| <b>Installed I/O &amp; Communication Module(s):</b>                                 |     |                        |    |   |   |   |   |
| C_ = CANopen (Available all models)   |     | The "_ " blank can be: |    |   |   |   |   |
| D_ = DeviceNet (Available all models)   |     | 0 = Standard Keypad    |    |   |   |   |   |
| E_ = Ethernet/IP, (Available all models)  |     |                        |    |   |   |   |   |
| R_ = RS-485 / ModBus /Lecom (Avail all models)                                      |     |                        |    |   |   |   |   |
| P_ = Profibus-DP (Available all models)   |     |                        |    |   |   |   |   |
| N_ = No Communications installed  |     |                        |    |   |   |   |   |
| <b>Input Voltage:</b>   |     |                        |    |   |   |   |   |
| 1 = 120 VAC (doubler output) or 240 VAC   |     |                        |    |   |   |   |   |
| 2 = 240 VAC   |     |                        |    |   |   |   |   |
| 4 = 400/480 VAC   |     |                        |    |   |   |   |   |
| 6 = 600 VAC   |     |                        |    |   |   |   |   |
| <b>Input Phase:</b>   |     |                        |    |   |   |   |   |
| S = Single Phase Input only   |     |                        |    |   |   |   |   |
| Y = Single or Three Phase Input   |     |                        |    |   |   |   |   |
| T = Three Phase Input only  |     |                        |    |   |   |   |   |
| <b>Input Line Filter</b>  |     |                        |    |   |   |   |   |
| F = Integral EMC Filter   |     |                        |    |   |   |   |   |
| L = Integral EMC Filter and Integrated Disconnect Switch (NEMA 4X/IP65 Models only) |     |                        |    |   |   |   |   |
| M = Integrated Disconnect Switch (NEMA 4X/IP65 Models only)                         |     |                        |    |   |   |   |   |
| X = No EMC Filter/ No Disconnect Switch   |     |                        |    |   |   |   |   |
| <b>Enclosure:</b>   |     |                        |    |   |   |   |   |
| B = NEMA 1/IP31; Indoor only  |     |                        |    |   |   |   |   |
| C = NEMA 4X/IP65; Indoor only; Convection cooled                                    |     |                        |    |   |   |   |   |
| D = NEMA 4X/IP65; Indoor only; Fan cooled   |     |                        |    |   |   |   |   |
| E = NEMA 4X/IP65; Indoor/Outdoor; Convection cooled                                 |     |                        |    |   |   |   |   |
| F = NEMA 4X/IP65; Indoor/Outdoor; Fan cooled  |     |                        |    |   |   |   |   |



#### NOTE

Prior to installation make sure the enclosure is suitable for the end-use environment

Variables that influence enclosure suitability include (but are not limited to) temperature, airborne contaminants, chemical concentration, mechanical stress and duration of exposure (sunlight, wind, precipitation).

## Technical Data



### 2.3 Ratings

#### 120V / 240VAC Models

| Mains = 120V Single Phase (1/N/PE) (90...132V), 240V Single Phase (2/PE) (170...264V); 48...62Hz |       |      |               |           |                             |            |                   |                       |                       |
|--|-------|------|---------------|-----------|-----------------------------|------------|-------------------|-----------------------|-----------------------|
| Type   | Power |      | Mains Current |           | Output Current              |            | Heat Loss (Watts) |                       |                       |
|  | Hp    | kW   | 120V<br>A     | 240V<br>A | Cont (I <sub>n</sub> )<br>A | Max I<br>% | N1/IP31           | N4X/IP65<br>No filter | N4X/IP65<br>W/ filter |
| ESV251--1S--   | 0.33  | 0.25 | 6.8           | 3.4       | 1.7                         | 200        | 24                |                       |                       |
| ESV371--1S--   | 0.5   | 0.37 | 9.2           | 4.6       | 2.4                         | 200        | 32                | 32                    |                       |
| ESV751--1S--   | 1     | 0.75 | 16.6          | 8.3       | 4.2                         | 200        | 52                | 41                    |                       |
| ESV112--1S--   | 1.5   | 1.1  | 20            | 10.0      | 6.0                         | 200        | 74                | 74                    |                       |

**NOTES:**

Output Current: The Output Current Maximum (%) is a percentage of the Output Current Continuous Amps (In) rating and is adjustable in parameter P171.

#### 240VAC Models

| Mains = 240V Single Phase (2/PE) (170...264V); 48...62Hz |       |      |               |  |                             |            |                   |                       |                       |
|--|-------|------|---------------|--|-----------------------------|------------|-------------------|-----------------------|-----------------------|
| Type   | Power |      | Mains Current |  | Output Current              |            | Heat Loss (Watts) |                       |                       |
|  | Hp    | kW   | 240V<br>A     |  | Cont (I <sub>n</sub> )<br>A | Max I<br>% | N1/IP31           | N4X/IP65<br>No filter | N4X/IP65<br>W/ filter |
| ESV251--2S--   | 0.33  | 0.25 | 3.4           |  | 1.7                         | 200        | 20                |                       |                       |
| ESV371--2S--   | 0.5   | 0.37 | 5.1           |  | 2.4                         | 200        |                   |                       | 30                    |
| ESV751--2S--   | 1     | 0.75 | 8.8           |  | 4.2                         | 200        |                   |                       | 42                    |
| ESV112--2S--   | 1.5   | 1.1  | 12.0          |  | 6.0                         | 200        |                   |                       | 63                    |
| ESV152--2S--   | 2     | 1.5  | 13.3          |  | 7.0                         | 200        |                   |                       | 73                    |
| ESV222--2S--   | 3     | 2.2  | 17.1          |  | 9.6                         | 200        |                   |                       | 97                    |

| 240V Single Phase (2/PE) (170...264V), 240V Three Phase (3/PE) (170...264V); 48...62Hz |       |      |                |                |                             |            |                   |                       |                       |
|--|-------|------|----------------|----------------|-----------------------------|------------|-------------------|-----------------------|-----------------------|
| Type   | Power |      | Mains Current  |                | Output Current              |            | Heat Loss (Watts) |                       |                       |
|  | Hp    | kW   | 1- (2/PE)<br>A | 3- (3/PE)<br>A | Cont (I <sub>n</sub> )<br>A | Max I<br>% | N1/IP31           | N4X/IP65<br>No filter | N4X/IP65<br>W/ filter |
| ESV371--2Y--   | 0.5   | 0.37 | 5.1            | 2.9            | 2.4                         | 200        | 27                | 26                    |                       |
| ESV751--2Y--   | 1     | 0.75 | 8.8            | 5.0            | 4.2                         | 200        | 41                | 38                    |                       |
| ESV112--2Y--   | 1.5   | 1.1  | 12.0           | 6.9            | 6.0                         | 200        | 64                | 59                    |                       |
| ESV152--2Y--   | 2     | 1.5  | 13.3           | 8.1            | 7.0                         | 200        | 75                | 69                    |                       |
| ESV222--2Y--   | 3     | 2.2  | 17.1           | 10.8           | 9.6                         | 200        | 103               | 93                    |                       |

| 240V Three Phase (3/PE) (170...264V); 48...62Hz |       |    |               |  |                             |            |                   |                       |                       |
|---|-------|----|---------------|--|-----------------------------|------------|-------------------|-----------------------|-----------------------|
| Type  | Power |    | Mains Current |  | Output Current              |            | Heat Loss (Watts) |                       |                       |
|   | Hp    | kW | 240V<br>A     |  | Cont (I <sub>n</sub> )<br>A | Max I<br>% | N1/IP31           | N4X/IP65<br>No filter | N4X/IP65<br>W/ filter |





## Technical Data

|              |     |     |      |      |     |     |     |  |
|--------------|-----|-----|------|------|-----|-----|-----|--|
| ESV112--2T-- | 1.5 | 1.1 | 6.9  | 6    | 200 | 64  |     |  |
| ESV152--2T-- | 2   | 1.5 | 8.1  | 7    | 200 | 75  |     |  |
| ESV222--2T-- | 3   | 2.2 | 10.8 | 9.6  | 200 | 103 |     |  |
| ESV402--2T-- | 5   | 4.0 | 18.6 | 16.5 | 200 | 154 | 139 |  |
| ESV552--2T-- | 7.5 | 5.5 | 26   | 23   | 200 | 225 | 167 |  |
| ESV752--2T-- | 10  | 7.5 | 33   | 29   | 200 | 274 | 242 |  |
| ESV113--2T-- | 15  | 11  | 48   | 42   | 180 | 485 | 468 |  |
| ESV153--2T-- | 20  | 15  | 59   | 54   | 180 | 614 | 591 |  |

### NOTES:

Output Current: The Output Current Maximum (%) is a percentage of the Output Current Continuous Amps (In) rating and is adjustable in parameter P171.

### 400...480VAC Models

| 400 ... 480V Three Phase (3/PE) (400V: 340...440V), (480V: 340...528V); 48...62Hz |       |      |               |           |                             |      |            |      |                   |                       |                       |
|---|-------|------|---------------|-----------|-----------------------------|------|------------|------|-------------------|-----------------------|-----------------------|
| Type  | Power |      | Mains Current |           | Output Current              |      |            |      | Heat Loss (Watts) |                       |                       |
|   | Hp    | kW   | 400V<br>A     | 480V<br>A | Cont (I <sub>n</sub> )<br>A |      | Max I<br>% |      | N1/IP31           | N4X/IP65<br>No filter | N4X/IP65<br>W/ filter |
|   |       |      |               |           | 400V                        | 480V | 400V       | 480V |                   |                       |                       |
| ESV371--4T--  | 0.5   | 0.37 | 1.7           | 1.5       | 1.3                         | 1.1  | 175        | 200  | 23                | 21                    | 25                    |
| ESV751--4T--  | 1     | 0.75 | 2.9           | 2.5       | 2.4                         | 2.1  | 175        | 200  | 37                | 33                    | 37                    |
| ESV112--4T--  | 1.5   | 1.1  | 4.2           | 3.6       | 3.5                         | 3.0  | 175        | 200  | 48                | 42                    | 46                    |
| ESV152--4T--  | 2     | 1.5  | 4.7           | 4.1       | 4.0                         | 3.5  | 175        | 200  | 57                | 50                    | 54                    |
| ESV222--4T--  | 3     | 2.2  | 6.1           | 5.4       | 5.5                         | 4.8  | 175        | 200  | 87                | 78                    | 82                    |
| ESV302--4T--  | 4     | 3.0  | 8.3           | 7.0       | 7.6                         | 6.3  | 175        | 200  |                   |                       | 95                    |
| ESV402--4T--  | 5     | 4.0  | 10.6          | 9.3       | 9.4                         | 8.2  | 175        | 200  | 128               | 103                   | 111                   |
| ESV552--4T--  | 7.5   | 5.5  | 14.2          | 12.4      | 12.6                        | 11.0 | 175        | 200  | 178               | 157                   | 165                   |
| ESV752--4T--  | 10    | 7.5  | 18.1          | 15.8      | 16.1                        | 14.0 | 175        | 200  | 208               | 190                   | 198                   |
| ESV113--4T--  | 15    | 11   | 27            | 24        | 24                          | 21   | 155        | 180  | 418               | 388                   | 398                   |
| ESV153--4T--  | 20    | 15   | 35            | 31        | 31                          | 27   | 155        | 180  | 493               | 449                   | 459                   |
| ESV183--4T--  | 25    | 18.5 | 44            | 38        | 39                          | 34   | 155        | 180  | 645               | 589                   | 600                   |
| ESV223--4T--  | 30    | 22   | 52            | 45        | 46                          | 40   | 155        | 180  | 709               | 637                   | 647                   |
| ESV303--4T--  | 40    | 30   | 68            | 59        | 60                          | 52   | 155        | 180  | 1020              |                       |                       |
| ESV373--4T--  | 50    | 37.5 | 85            | 74        | 75                          | 65   | 155        | 180  | 1275              |                       |                       |
| ESV453--4T--  | 60    | 45   | 100           | 87        | 88                          | 77   | 155        | 180  | 1530              |                       |                       |

### NOTES:

Output Current: The Output Current Maximum (%) is a percentage of the Output Current Continuous Amps (In) rating and is adjustable in parameter P171.

For 400...480 VAC models, the output current maximum (%) in the 400V column is used when P107 = 0

For 400...480 VAC models, the output current maximum (%) in the 480V column is used when P107 = 1

## Technical Data



### 600VAC Models

| 600V Three Phase (3/PE) (425...660V); 48...62Hz |       |      |               |                             |            |                   |                       |                       |
|---|-------|------|---------------|-----------------------------|------------|-------------------|-----------------------|-----------------------|
| Type  | Power |      | Mains Current | Output Current              |            | Heat Loss (Watts) |                       |                       |
|   | Hp    | kW   | A             | Cont (I <sub>n</sub> )<br>A | Max I<br>% | N1/IP31           | N4X/IP65<br>No filter | N4X/IP65<br>W/ filter |
| ESV751--6T--                                    | 1     | 0.75 | 2             | 1.7                         | 200        | 37                | 31                    |                       |
| ESV152--6T--                                    | 2     | 1.5  | 3.2           | 2.7                         | 200        | 51                | 43                    |                       |
| ESV222--6T--                                    | 3     | 2.2  | 4.4           | 3.9                         | 200        | 68                | 57                    |                       |
| ESV402--6T--                                    | 5     | 4    | 6.8           | 6.1                         | 200        | 101               | 67                    |                       |
| ESV552--6T--                                    | 7.5   | 5.5  | 10.2          | 9                           | 200        | 148               | 116                   |                       |
| ESV752--6T--                                    | 10    | 7.5  | 12.4          | 11                          | 200        | 172               | 152                   |                       |
| ESV113--6T--                                    | 15    | 11   | 19.7          | 17                          | 180        | 380               | 356                   |                       |
| ESV153--6T--                                    | 20    | 15   | 25            | 22                          | 180        | 463               | 431                   |                       |
| ESV183--6T--                                    | 25    | 18.5 | 31            | 27                          | 180        | 560               | 519                   |                       |
| ESV223--6T--                                    | 30    | 22   | 36            | 32                          | 180        | 640               | 592                   |                       |
| ESV303--6T--                                    | 40    | 30   | 47            | 41                          | 180        | 930               |                       |                       |
| ESV373--6T--                                    | 50    | 37.5 | 59            | 52                          | 180        | 1163              |                       |                       |
| ESV453--6T--                                    | 60    | 45   | 71            | 62                          | 180        | 1395              |                       |                       |

**NOTES:**

Output Current: The Output Current Maximum (%) is a percentage of the Output Current Continuous Amps (In) rating and is adjustable in parameter P171.



**STOP!**

- For installations above 1000m a.m.s.l., derate I<sub>n</sub> by 5% per 1000m, do not exceed 4000m a.m.s.l.
- Operation above 40°C, derate I<sub>n</sub> by 2.5% per °C, do not exceed 55°C.

Output Current (In) derating for Carrier Frequency (P166) for NEMA 1 (IP31) Models:

- If P166=2 (8 kHz), derate I<sub>n</sub> to 92% of drive rating
- If P166=3 (10 kHz), derate I<sub>n</sub> to 84% of drive rating

Output Current (In) derating for Carrier Frequency (P166) for NEMA 4X (IP65) Models:

- If P166=1 (6 kHz), derate I<sub>n</sub> to 92% of drive rating
- If P166=2 (8 kHz), derate I<sub>n</sub> to 84% of drive rating
- If P166=3 (10 kHz), derate I<sub>n</sub> to 76% of drive rating



## Installation

### 3 Installation

#### 3.1 Dimensions and Mounting



##### WARNING!

Drives must not be installed where subjected to adverse environmental conditions such as: combustible, oily, or hazardous vapors; corrosive chemicals; excessive dust, moisture or vibration; direct sunlight or extreme temperatures.

##### 3.1.1 NEMA 1 (IP31) Models ≤ 30HP (22kW)

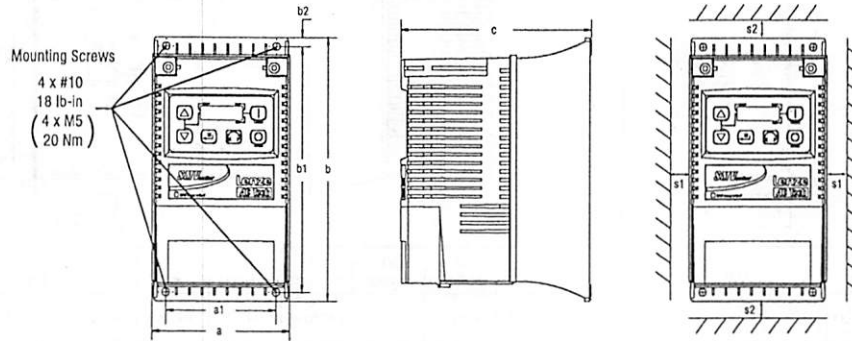

| Type   | a<br>in (mm) | a1<br>in (mm) | b<br>in (mm) | b1<br>in (mm) | b2<br>in (mm) | c<br>in (mm) | s1<br>in (mm) | s2<br>in (mm) | m<br>lb (kg) |
|--|--------------|---------------|--------------|---------------|---------------|--------------|---------------|---------------|--------------|
| G1<br>ESV251-----B; ESV371-----B<br>ESV751-----B               | 3.90 (99)    | 3.12 (79)     | 7.48 (190)   | 7.00 (178)    | 0.24 (6)      | 4.35 (111)   | 0.6 (15)      | 2.0 (50)      | 2.0 (0.9)    |
| G2<br>ESV112-----B; ESV152-----B<br>ESV222-----B               | 3.90 (99)    | 3.12 (79)     | 7.52 (191)   | 7.00 (178)    | 0.26 (7)      | 5.45 (138)   | 0.6 (15)      | 2.0 (50)      | 2.8 (1.3)    |
| G3<br>ESV402-----B   | 3.90 (99)    | 3.12 (79)     | 7.52 (191)   | 7.00 (178)    | 0.30 (8)      | 5.80 (147)   | 0.6 (15)      | 2.0 (50)      | 3.2 (1.5)    |
| H1<br>ESV552-----B; ESV752-----B                               | 5.12 (130)   | 4.25 (108)    | 9.83 (250)   | 9.30 (236)    | 0.26 (7)      | 6.30 (160)   | 0.6 (15)      | 2.0 (50)      | 6.0 (2.0)    |
| J1<br>ESV113-----B; ESV153-----B<br>ESV183-----B; ESV223-----B | 6.92 (176)   | 5.75 (146)    | 12.50 (318)  | 11.88 (302)   | 0.31 (8)      | 8.09 (205)   | 0.6 (15)      | 2.0 (50)      | 13.55 (6.15) |

| Conduit Hole Dimensions | Type | N<br>in (mm) | P<br>in (mm) | P1<br>in (mm) | Q<br>in (mm) | S<br>in (mm)          |
|-------------------------|------|--------------|--------------|---------------|--------------|-----------------------|
|                         | G1   | 1.84 (47)    | 1.93 (49)    | .70 (18)      | 1.00 (25)    | .88 (22)              |
|                         | G2   | 1.84 (47)    | 3.03 (77)    | .70 (18)      | 1.00 (25)    | .88 (22)              |
|                         | G3   | 1.84 (47)    | 3.38 (86)    | .70 (18)      | 1.00 (25)    | .88 (22)              |
|                         | H1   | 2.46 (62)    | 3.55 (90)    | .13 (3)       | 1.38 (35)    | 1.13 (29)<br>.88 (22) |
|                         | J1   | 3.32 (84)    | 4.62 (117)   | .73 (19)      | 1.40 (36)    | 1.31 (33)             |
|                         |      |              |              |               |              | .88 (22)              |

## Installation



### 3.1.2 NEMA 1 (IP31) Models > 30HP (22kW)

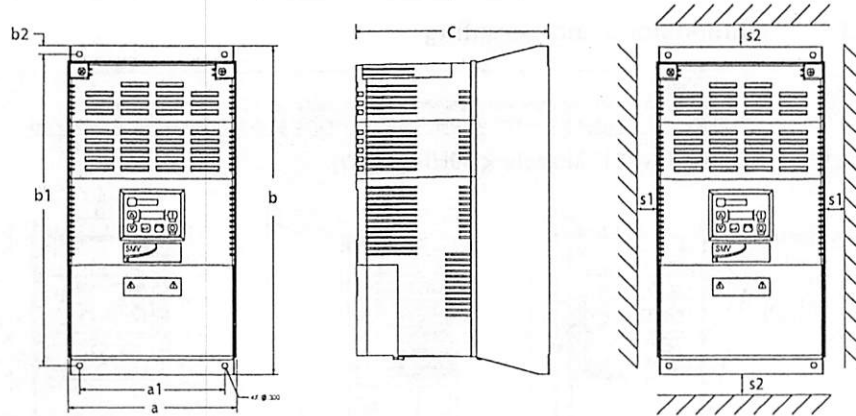

| Type                                | a<br>in (mm) | a1<br>in (mm) | b<br>in (mm) | b1<br>in (mm) | b2<br>in (mm) | c<br>in (mm) | s1<br>in (mm) | s2<br>in (mm) | m<br>lb (kg) |
|-------------------------------------|--------------|---------------|--------------|---------------|---------------|--------------|---------------|---------------|--------------|
| K1<br>ESV303--4--B;<br>ESV303--6--B | 8.72 (221)   | 7.50 (190)    | 14.19 (360)  | 13.30 (338)   | 0.45 (11.4)   | 10.07 (256)  | 0.6 (15)      | 2.0 (50)      | 24 (10.9)    |
| K2<br>ESV373--4--B;<br>ESV373--6--B | 8.72 (221)   | 7.50 (190)    | 17.19 (436)  | 16.30 (414)   | 0.45 (11.4)   | 10.07 (256)  | 0.6 (15)      | 2.0 (50)      | 31 (14.1)    |
| K3<br>ESV453--4--B<br>ESV453--6--B  | 8.72 (221)   | 7.50 (190)    | 20.19 (513)  | 19.30 (490)   | 0.45 (11.4)   | 10.07 (256)  | 0.6 (15)      | 2.0 (50)      | 35 (15.9)    |

| Conduit Hole Dimensions |    | Type      | N<br>in (mm) | P<br>in (mm) | P1<br>in (mm) | Q<br>in (mm) | S<br>in (mm) | S1<br>in (mm) |
|-------------------------|----|-----------|--------------|--------------|---------------|--------------|--------------|---------------|
|                         | K1 | 3.75 (95) | 5.42 (137)   | 1.50 (38.1)  | 1.75 (44.4)   | 1.75 (44.4)  | 0.875 (22.2) |               |
|                         | K2 | 3.75 (95) | 5.42 (137)   | 1.50 (38.1)  | 1.75 (44.4)   | 1.75 (44.4)  | 0.875 (22.2) |               |
|                         | K3 | 3.75 (95) | 5.42 (137)   | 1.50 (38.1)  | 1.75 (44.4)   | 1.75 (44.4)  | 0.875 (22.2) |               |



## Installation

### 3.1.3 NEMA 4X (IP65) Models

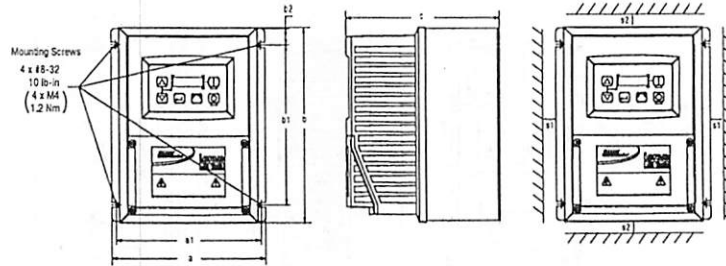

| Type  | a<br>in (mm) | a1<br>in (mm) | b<br>in (mm) | b1<br>in (mm) | b2<br>in (mm) | c<br>in (mm) | s1<br>in (mm) | s2<br>in (mm) | m<br>lb (kg) |
|---|--------------|---------------|--------------|---------------|---------------|--------------|---------------|---------------|--------------|
| R1<br>ESV371N01SX_ ; ESV751N01SX_ ;<br>ESV371N02YX_ ; ESV751N02YX_ ;<br>ESV371N04TX_ ; ESV751N04TX_ ;<br>ESV371N06TX_ ; ESV371N02SF_ ;<br>ESV751N02SF_ ; ESV371N04TF_ ;<br>ESV751N04TF_ ;   | 6.28 (160)   | 5.90 (150)    | 8.00 (203)   | 6.56 (167)    | 0.66 (17)     | 4.47 (114)   | 2.00 (51)     | 2.00 (51)     | 3.6 (1.63)   |
| R2<br>ESV112N01SX_ ; ESV112N02YX_ ;<br>ESV152N02YX_ ; ESV112N04TX_ ;<br>ESV152N04TX_ ; ESV222N04TX_ ;<br>ESV152N06TX_ ; ESV222N06TX_ ;<br>ESV112N02SF_ ; ESV152N02SF_ ;<br>ESV112N04TF_ ; ESV152N04TF_ ;<br>ESV222N04TF_ ; ESV302N04TF_ ; | 6.28 (160)   | 5.90 (150)    | 8.00 (203)   | 6.56 (167)    | 0.66 (17)     | 6.31 (160)   | 2.00 (51)     | 2.00 (51)     | 5.9 (2.68)   |
| S1<br>ESV222N02YX_ ; ESV222N02SF_ ;   | 7.12 (181)   | 6.74 (171)    | 8.00 (203)   | 6.56 (167)    | 0.66 (17)     | 6.77 (172)   | 2.00 (51)     | 2.00 (51)     | 7.1 (3.24)   |
| T1<br>ESV552N02TX- ; ESV752N02TX- ;<br>ESV752N04TX- ; ESV752N06TX- ;<br>ESV752N04TF- ;  | 8.04 (204)   | 7.56 (192)    | 10.00 (254)  | 8.04 (204)    | 0.92 (23)     | 8.00 (203)   | 4.00 (102)    | 4.00 (102)    | 10.98 (4.98) |
| V1<br>ESV402N02TX_ ; ESV402N04TX_ ;<br>ESV552N04TX_ ; ESV402N06TX_ ;<br>ESV552N06TX_ ; ESV402N04TF_ ;<br>ESV552N04TF_ ;   | 8.96 (228)   | 8.48 (215)    | 10.00 (254)  | 8.04 (204)    | 0.92 (23)     | 8.00 (203)   | 4.00 (102)    | 4.00 (102)    | 11.58 (5.25) |
| W1<br>ESV113N02TX- ; ESV153N02TX- ;<br>ESV113N04TX- ; ESV153N04TX- ;<br>ESV113N04TF- ; ESV153N04TF- ;<br>ESV113N06TX- ; ESV153N06TX- ;<br>ESV183N04TX- ; ESV183N04TF- ;<br>ESV183N06TX- ;   | 9.42 (240)   | 8.94 (228)    | 14.50 (368)  | 12.54 (319)   | 0.92 (24)     | 9.45 (241)   | 4.00 (102)    | 4.00 (102)    | 22.0 (10.0)  |
| X1<br>ESV223N04TX- ; ESV223N04TF- ;<br>ESV223N06TX- ;   | 9.42 (240)   | 8.94 (228)    | 18.5 (470)   | 16.54 (420)   | 0.92 (24)     | 9.45 (241)   | 4.00 (102)    | 4.00 (102)    | 25.5 (11.6)  |

\_ = Last digit of part number:

C = N4X Indoor (convection cooled)

- = Last digit of part number:

D = N4X Indoor (fan cooled)

E = N4X In/Outdoor (convection cooled)

F = N4X In/Outdoor (fan cooled)

| Conduit Hole Dimensions |  | Type | N<br>in (mm) | P<br>in (mm) | Q<br>in (mm) | S<br>in (mm) | S1<br>in (mm) |
|-------------------------|--|------|--------------|--------------|--------------|--------------|---------------|
|                         |  | R1   | 3.14 (80)    | 2.33 (59)    | 1.50 (38)    | .88 (22)     | n/a           |
|                         |  | R2   | 3.14 (80)    | 4.18 (106)   | 1.50 (38)    | .88 (22)     | n/a           |
|                         |  | S1   | 3.56 (90)    | 4.63 (118)   | 1.50 (38)    | .88 (22)     | n/a           |
|                         |  | T1   | 4.02 (102)   | 5.00 (127)   | 1.85 (47)    | 1.06 (27)    | n/a           |
|                         |  | V1   | 4.48 (114)   | 5.00 (127)   | 1.85 (47)    | 1.06 (27)    | n/a           |
|                         |  | W1   | 4.71 (120)   | 5.70 (145)   | 2.00 (51)    | 1.375 (35)   | 1.125 (28)    |
|                         |  | X1   | 4.71 (120)   | 5.70 (145)   | 2.00 (51)    | 1.375 (35)   | 1.125 (28)    |

## Installation



### 3.1.4 NEMA 4X (IP65) Models with Disconnect Switch

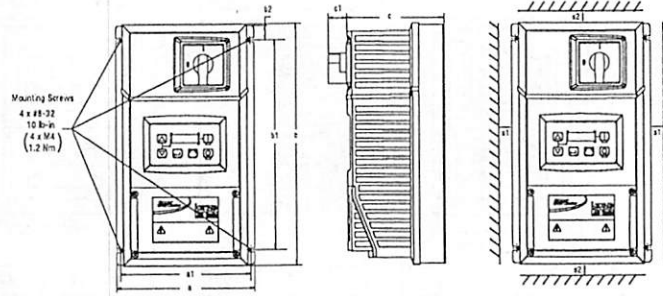

| Type   | a<br>in<br>(mm) | a1<br>in<br>(mm) | b<br>in<br>(mm) | b1<br>in<br>(mm) | b2<br>in<br>(mm) | c<br>in<br>(mm) | c1<br>in<br>(mm) | s1<br>in<br>(mm) | s2<br>in<br>(mm) | m<br>lb<br>(kg) |
|--|-----------------|------------------|-----------------|------------------|------------------|-----------------|------------------|------------------|------------------|-----------------|
| AA1<br>ESV371N01SM_ ; ESV371N02YM_ ;<br>ESV371N02SL_ ; ESV371N04TM_ ;<br>ESV371N04TL_ ; ESV371N06TM_ ;<br>ESV751N01SM_ ; ESV751N02YM_ ;<br>ESV751N02SL_ ; ESV751N04TM_ ;<br>ESV751N04TL_ ; ESV751N06TM_ ;                                  | 6.28<br>(160)   | 5.90<br>(150)    | 10.99<br>(279)  | 9.54<br>(242)    | 0.66<br>(17)     | 4.47<br>(114)   | .86<br>(22)      | 2.00<br>(51)     | 2.00<br>(51)     | 4.7<br>(2.13)   |
| AA2<br>ESV112N01SM_ ; ESV112N02YM_ ;<br>ESV112N02SL_ ; ESV112N04TM_ ;<br>ESV112N04TL_ ; ESV152N02YM_ ;<br>ESV152N02SL_ ; ESV152N04TM_ ;<br>ESV152N04TL_ ; ESV152N06TM_ ;<br>ESV222N04TM_ ; ESV222N04TL_ ;<br>ESV222N06TM_ ; ESV302N04TL_ ; | 6.28<br>(160)   | 5.90<br>(150)    | 10.99<br>(279)  | 9.54<br>(242)    | 0.66<br>(17)     | 6.31<br>(160)   | .86<br>(22)      | 2.00<br>(51)     | 2.00<br>(51)     | 7.9<br>(3.58)   |
| AD1<br>ESV222N02SL_ ; ESV222N02YM_ ;   | 7.12<br>(181)   | 6.74<br>(171)    | 10.99<br>(279)  | 9.54<br>(242)    | 0.66<br>(17)     | 6.77<br>(172)   | .86<br>(22)      | 2.00<br>(51)     | 2.00<br>(51)     | 9.0<br>(4.08)   |
| AB1<br>ESV552N02TM_ ; ESV752N02TM_ ;<br>ESV752N04TM_ ; ESV752N06TM_ ;<br>ESV752N04TL_ ;  | 8.04<br>(204)   | 7.56<br>(192)    | 13.00<br>(330)  | 11.04<br>(280)   | 0.92<br>(23)     | 8.00<br>(203)   | .86<br>(22)      | 4.00<br>(102)    | 4.00<br>(102)    | 13.9<br>(6.32)  |
| AC1<br>ESV402N02TM_ ; ESV402N04TM_ ;<br>ESV552N04TM_ ; ESV402N06TM_ ;<br>ESV552N06TM_ ; ESV402N04TL_ ;<br>ESV552N04TL_ ;   | 8.96<br>(228)   | 8.48<br>(215)    | 13.00<br>(330)  | 11.04<br>(280)   | 0.92<br>(23)     | 8.04<br>(204)   | .86<br>(22)      | 4.00<br>(102)    | 4.00<br>(102)    | 14.7<br>(6.66)  |
| AE1<br>ESV113N04TM_ ; ESV153N04TM_ ;<br>ESV113N06TM_ ; ESV153N06TM_ ;  | 9.42<br>(240)   | 8.94<br>(228)    | 14.50<br>(368)  | 12.54<br>(319)   | 0.92<br>(24)     | 9.45<br>(241)   | 0.73<br>(19)     | 4.00<br>(102)    | 4.00<br>(102)    | 23.0<br>(10.4)  |
| AF1<br>ESV113N02TM_ ; ESV153N02TM_ ;<br>ESV113N04TL_ ; ESV153N04TL_ ;<br>ESV183N04TL_ ; ESV223N04TL_ ;<br>ESV183N04TM_ ; ESV223N04TM_ ;<br>ESV183N06TM_ ; ESV223N06TM_ ;   | 9.42<br>(240)   | 8.94<br>(228)    | 18.5<br>(470)   | 16.54<br>(420)   | 0.92<br>(24)     | 9.45<br>(241)   | 0.73<br>(19)     | 4.00<br>(102)    | 4.00<br>(102)    | 28.5<br>(12.9)  |

\_ = Last digit of part number: C = N4X Indoor (convection cooled)      - = Last digit of part number: D = N4X Indoor (fan cooled)

| Conduit Hole Dimensions |  | Type | N<br>in (mm) | P<br>in (mm) | Q<br>in (mm) | S<br>in (mm) | S1<br>in (mm) |
|-------------------------|--|------|--------------|--------------|--------------|--------------|---------------|
|                         |  | AA1  | 3.14 (80)    | 2.33 (59)    | 1.50 (38)    | .88 (22)     | n/a           |
|                         |  | AA2  | 3.14 (80)    | 4.18 (106)   | 1.50 (38)    | .88 (22)     | n/a           |
|                         |  | AD1  | 3.56 (90)    | 4.63 (118)   | 1.50 (38)    | .88 (22)     | n/a           |
|                         |  | AB1  | 4.02 (102)   | 5.00 (127)   | 1.85 (47)    | 1.06 (27)    | n/a           |
|                         |  | AC1  | 4.48 (114)   | 5.00 (127)   | 1.85 (47)    | 1.06 (27)    | n/a           |
|                         |  | AE1  | 4.71 (120)   | 5.70 (145)   | 2.00 (51)    | 1.375 (35)   | 1.125 (28)    |
|                         |  | AF1  | 4.71 (120)   | 5.70 (145)   | 2.00 (51)    | 1.375 (35)   | 1.125 (28)    |



# Installation

## 3.2 Electrical Installation

### Installation After a Long Period of Storage



#### STOP!

Severe damage to the drive can result if it is operated after a long period of storage or inactivity without reforming the DC bus capacitors.

If input power has not been applied to the drive for a period of time exceeding three years (due to storage, etc), the electrolytic DC bus capacitors within the drive can change internally, resulting in excessive leakage current. This can result in premature failure of the capacitors if the drive is operated after such a long period of inactivity or storage.

In order to reform the capacitors and prepare the drive for operation after a long period of inactivity, apply input power to the drive for 8 hours prior to actually operating the motor.

### 3.2.1 Power Connections



#### STOP!

If the kVA rating of the AC supply transformer is greater than 10 times the input kVA rating of the drive(s), an isolation transformer or 2-3% input line reactor must be added to the line side of the drive(s).



#### DANGER! Hazard of electrical shock!

Circuit potentials up to 600 VAC are possible. Capacitors retain charge after power is removed. Disconnect power and wait at least three minutes before servicing the drive.



#### STOP!

- Verify mains voltage before connecting to drive.
- Do not connect mains power to the output terminals (U,V,W)! Severe damage to the drive will result.
- Do not cycle mains power more than once every two minutes. Damage to the drive may result.

| Mains and Motor Terminations   |                          |                |  |
|--|--------------------------|----------------|--|
| Type   | Torque                   | Strip Length   |  |
| <5HP   | 12 lb-in (1.3 Nm)        | 5/16 in (8mm)  |  |
| ESV552xx2T, ESV752xx2T, ESV113xx4/6, ESV153xx4/6, ESV183xx6, ESV223xx6 | 16 lb-in (1.8 Nm)        | 5/16 in (8mm)  |  |
| ESV552xx4Txx, ESV752xx4Txx, ESV552xx6Txx, ESV752xx6Txx                 | 12 lb-in (1.3Nm)         | 0.25 in (6mm)  |  |
| ESV113xx2xxx, ESV153xx2xxx, ESV183xx4xxx, ESV223xx4xxx, ESV303xx4xxx   | 24 lb-in (2.7 Nm)        | 7/16 in (10mm) |  |
| ESV373xx4xxx, ESV453xx4xxx   | 27 lb-in (3.05 Nm)       | 0.75 in (19mm) |  |
| Torque: N4X/IP65 Door Screws   |                          |                |  |
| N4X/IP65   | 6-7 lb-in (0.67-0.79 Nm) | 0.25 in (6mm)  |  |

### 3.2.1.1 Mains Connection to 120VAC Single-Phase Supply

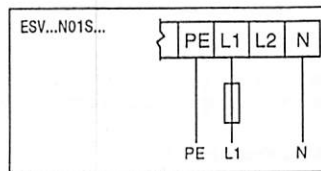

## Installation



### 3.2.1.2 Mains Connection to 240VAC Single-Phase Supply

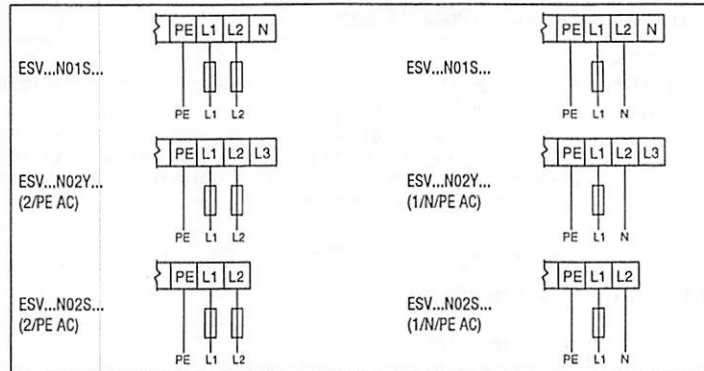

### 3.2.1.3 Mains Connection to Three-Phase Supply

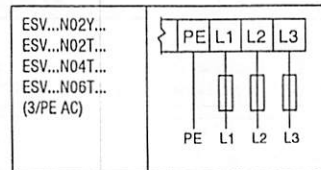

### 3.2.1.4 Motor Connection

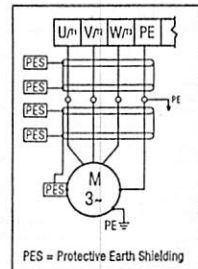

#### WARNING!

If the cable connection between the drive and the motor has an in-line contactor or circuit breaker then the drive must be stopped prior to opening/closing the contacts. Failure to do so may result in overcurrent trips and/or damage to the inverter.



#### WARNING!

Leakage current may exceed 3.5 mA AC. The minimum size of the protective earth (PE) conductor shall comply with local safety regulations for high leakage current equipment.



#### STOP!

In the case of a Spinning Motor:

To bring free-wheeling loads such as fans to a rest before starting the drive, use the DC injection braking function. Starting a drive into a freewheeling motor creates a direct short-circuit and may result in damage to the drive.

Confirm motor suitability for use with DC injection braking.  
Consult parameter P110 for starting / restarting into spinning motors.





## Installation

### 3.2.1.5 Installation Recommendations for EMC Compliance

For compliance with EN 61800-3 or other EMC standards, motor cables, line cables and control or communications cables must be shielded with each shield/screen clamped to the drive chassis. This clamp is typically located at the conduit mounting plate.

The EMC requirements apply to the final installation in its entirety, not to the individual components used. Because every installation is different, the recommended installation should follow these guidelines as a minimum. Additional equipment (such as ferrite core absorbers on power conductors) or alternative practices may be required to meet conformance in some installations.

Motor cable should be low capacitance (core/core <math><75\text{pF/m}</math>, core/shield <math><150\text{pF/m}</math>). Filtered drives can meet the class A limits of EN 55011 and EN 61800-3 Category 2 with this type of motor cable up to 10 meters.

**NOTE:** Refer to Appendix A for recommended cable lengths. Any external line filter should have its chassis connected to the drive chassis by mounting hardware or with the shortest possible wire or braid.

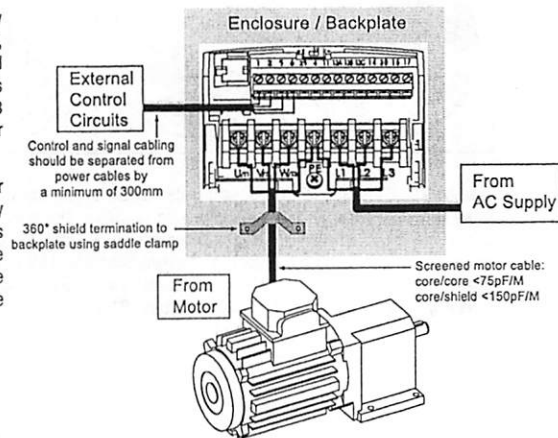

### 3.2.1.6 NEMA 4X (IP65) Input Terminal Block

For NEMA 4X (IP65) models with integrated EMC filter and/or integrated line disconnect, the input terminal block is located on the right-hand side of the SMV inverter in the NEMA 4 X (IP65) enclosure. The single and three phase models are illustrated herein. Refer to paragraph 3.2.3 Control Terminals for pin out information.

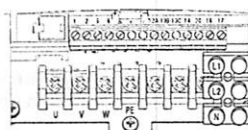

Single Phase (2/PE) 120/240 VAC models (ESVxxxN01SMC) with integrated line disconnect

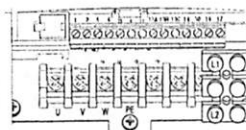

Single Phase (2/PE) 240 VAC models with Filter and/or integrated line disconnect

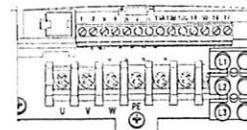

Three Phase (3/PE) models with Filter and/or integrated line disconnect



#### WARNING

Power remains present for up to 3 minutes on power input terminals (L1, L2 and L3) and output terminals (U, V and W) even when the disconnect switch is in the OFF position. Remove input power ahead of the drive and wait 3 minutes before removing the terminal cover.

## Installation



### 3.2.1.7 Dynamic Brake Connections

For NEMA 1 and NEMA 4X Drives rated up to 30HP (22kW) the Dynamic Brake connections are made as illustrated herein. Refer to the SMV Dynamic Brake Instructions (DBV01) for complete information.

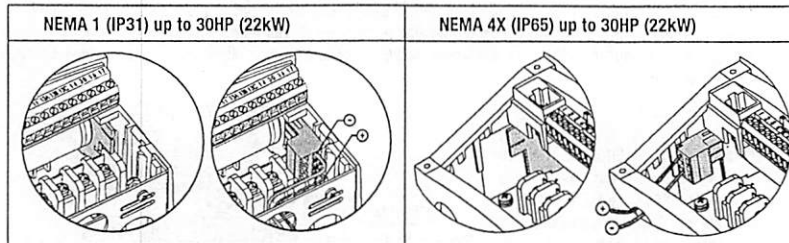

The SMV 40...60Hp (30...45kW) models include a dynamic brake transistor as standard and only require the connection of an external resistor kit for dynamic braking operation. The dynamic brake resistor connections for 40...60 Hp (30...45kW) drives are standard built-in connections as illustrated in the diagram below. In the 40Hp (30kW) model drives, the dynamic brake connector is on the right-hand side of the drive and the terminals from top to bottom are B-, BRAKE and B+. In the 50/60HP (37.5/45 kW) model drives, the dynamic brake connector is on the left-hand side of the drive and the terminals from top to bottom are B+, BRAKE and B-.

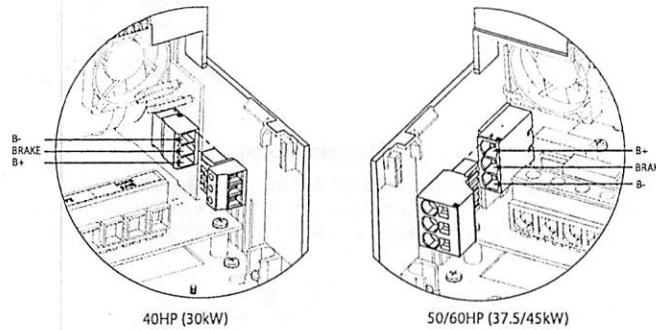

External resistor kits must be connected to terminals B+ and BRAKE (no connection to B-). Refer to the table herein for external resistor kit selection. Refer to parameter P189 for enabling the dynamic brake function in the 40...60Hp (30...45kW) models.

| 400/480 VAC SMV Inverter |    |    | Resistor Kit            |           |           |          |
|--------------------------|----|----|-------------------------|-----------|-----------|----------|
| Type                     | Hp | kW | Resistance ( $\Omega$ ) | Power (W) | Catalog # | SAP#     |
| ESV303**4T**             | 40 | 30 | 23.5                    | 1020      | 841-013   | 13317724 |
| ESV373**4T**             | 50 | 37 | 17                      | 1400      | 841-015   | 13317626 |
| ESV453**4T**             | 60 | 45 | 17                      | 1400      | 841-015   | 13317626 |
| 600 VAC SMV Inverter     |    |    | Resistor Kit            |           |           |          |
| Type                     | Hp | kW | Resistance ( $\Omega$ ) | Power (W) | Catalog # | SAP#     |
| ESV303**6T**             | 40 | 30 | 35                      | 1070      | 841-014   | 13317624 |
| ESV373**6T**             | 50 | 37 | 24                      | 1560      | 841-016   | 13317628 |
| ESV453**6T**             | 60 | 45 | 24                      | 1560      | 841-016   | 13317628 |



## Installation

### 3.2.2 Fuses/Cable Cross-Sections



**NOTE:** Observe local regulations. Local codes may supersede these recommendations



**WARNING:** Use a FUSE \* for 240V drives requiring > 40A protection and for 400/480/600V drives requiring >32A protection.

|  | Type   | Recommendations   |  |  |                                     |       |    |
|--|--|---|--|--|-------------------------------------|-------|----|
|  |  | Fuse  | Miniature circuit breaker <sup>(1)</sup> | Fuse <sup>(2)</sup> or Breaker <sup>(3)</sup> (N. America) | Input Power Wiring (L1, L2, L3, PE) |       |    |
|  |  |   |  |  | [mm <sup>2</sup> ]                  | [AWG] |    |
| 120V<br>1-<br>(1/N/PE)                   | ESV251N01SXB   | M10 A   | C10 A                                    | 10 A   | 1.5                                 | 14    |    |
|  | ESV371N01SXB, ESV371N01SX*   | M16 A   | C16 A                                    | 15 A   | 2.5                                 | 14    |    |
|  | ESV751N01SXB, ESV751N01SX*   | M25 A   | C25 A                                    | 25 A   | 4                                   | 10    |    |
|  | ESV112N01SXB, ESV112N01SX*   | M32 A   | C32 A                                    | 30 A   | 4                                   | 10    |    |
| 240V<br>1-<br>(2/PE)                     | ESV251N01SXB, ESV251N02SXB, ESV371N01SXB, ESV371N02YXB, ESV371N02SF*               | M10 A   | C10 A                                    | 10 A   | 1.5                                 | 14    |    |
|  | ESV751N01SXB, ESV751N02YXB, ESV751N02SF*   | M16 A   | C16 A                                    | 15 A   | 2.5                                 | 14    |    |
|  | ESV112N02YXB, ESV112N02SFC, ESV112N01SXB, ESV112N01SX*                             | M20 A   | C20 A                                    | 20 A   | 2.5                                 | 12    |    |
|  | ESV152N02YXB, ESV152N02SF*   | M25 A   | C25 A                                    | 25 A   | 2.5                                 | 12    |    |
|  | ESV222N02YXB, ESV222N02SF*   | M32 A   | C32 A                                    | 30 A   | 4                                   | 10    |    |
| 240V<br>3-<br>(3/PE)                     | ESV371N02YXB, ESV751N02YXB, ESV371N02Y_*, ESV751N02Y_*                             | M10 A   | C10 A                                    | 10 A   | 1.5                                 | 14    |    |
|  | ESV112N02YXB, ESV152N02YXB, ESV112N02TXB, ESV152N02TXB, ESV112N02Y_*, ESV152N02Y_* | M16 A   | C16 A                                    | 12 A   | 1.5                                 | 14    |    |
|  | ESV222N02YXB, ESV222N02TXB, ESV222N02YX*   | M20 A   | C20 A                                    | 20 A   | 2.5                                 | 12    |    |
|  | ESV402N02TXB, ESV402N02T_*   | M32 A   | C32 A                                    | 30 A   | 4.0                                 | 10    |    |
|  | ESV552N02TXB, ESV552N02T_*   | M40 A   | C40 A                                    | 35 A   | 6.0                                 | 8     |    |
|  | ESV752N02TXB, ESV752N02T_*   | M50 A   | * use Fuse only                          | 45 A *   | 10                                  | 8     |    |
|  | ESV113N02TXB, ESV113N02TX-, ESV113N02TM-   | M80 A   | * use Fuse only                          | 80 A *   | 16                                  | 6     |    |
|  | ESV153N02TXB, ESV153N02TX-, ESV153N02TM-   | M100 A  | * use Fuse only                          | 90 A *   | 16                                  | 4     |    |
|  | 400V<br>or 480V<br>3-<br>(3/PE)  | ESV371N04TXB, ...ESV222N04TXB, ESV371N04T_*, ...ESV222N04T_*, ESV371N04TF*, ...ESV222N04TF* | M10 A                                    | C10 A  | 10 A                                | 1.5   | 14 |
|  |  | ESV302N04T_*  | M16 A                                    | C16 A  | 15 A                                | 2.5   | 14 |
| ESV402N04TXB, ESV402N04T_*               |  | M16 A   | C16 A                                    | 20 A   | 2.5                                 | 14    |    |
| ESV552N04TXB, ESV552N04T_*               |  | M20 A   | C20 A                                    | 20 A   | 2.5                                 | 14    |    |
| ESV752N04TXB, ESV752N04T_*               |  | M25 A   | C25 A                                    | 25 A   | 4.0                                 | 10    |    |
| ESV113N04TXB, ESV113N04T_*               |  | M40 A   | * use Fuse only                          | 40 A *   | 4                                   | 8     |    |
| ESV153N04TXB, ESV153N04T_*               |  | M50 A   | * use Fuse only                          | 50 A *   | 10                                  | 8     |    |
| 400V<br>or 480V<br>3-<br>(3/PE)          | ESV183N04TXB, ESV183N04T_*   | M63 A   | * use Fuse only                          | 70 A *   | 10                                  | 6     |    |
|  | ESV223N04TXB, ESV223N04T_*   | M80 A   | * use Fuse only                          | 80 A *   | 16                                  | 6     |    |
|  | ESV303N04TXB   | M100 A  | * use Fuse only                          | 100 A *  | 25                                  | 4     |    |
|  | ESV373N04TXB   | M125 A  | * use Fuse only                          | 125 A *  | 35                                  | 2     |    |
|  | ESV453N04TXB   | M160 A  | * use Fuse only                          | 150 A *  | 35                                  | 1     |    |
|  | 600V<br>3-<br>(3/PE)   | ESV751N06TXB, ...ESV222N06TXB, ESV751N06T_*, ...ESV222N06T_*                                | M10 A                                    | C10 A  | 10 A                                | 1.5   | 14 |
| ESV402N06TXB, ESV402N06T_*               |  | M16 A   | C16 A                                    | 12 A   | 1.5                                 | 14    |    |
| ESV552N06TXB, ESV552N06T_*               |  | M16 A   | C16 A                                    | 15 A   | 2.5                                 | 14    |    |
| ESV752N06TXB, ESV752N06T_*               |  | M20 A   | C20 A                                    | 20 A   | 2.5                                 | 12    |    |
| ESV113N06TXB, ESV113N06TX-, ESV113N06TM- |  | M32 A   | C32 A                                    | 30 A   | 4                                   | 10    |    |
| ESV153N06TXB, ESV153N06TX-, ESV153N06TM- |  | M40 A   | * use Fuse only                          | 40 A *   | 4                                   | 8     |    |
| ESV183N06TXB, ESV183N06TX-, ESV183N06TM- |  | M50 A   | * use Fuse only                          | 50 A *   | 6                                   | 8     |    |
| ESV223N06TXB, ESV223N06TX-, ESV223N06TM- |  | M63 A   | * use Fuse only                          | 60 A *   | 10                                  | 8     |    |
| ESV303N06TXB                             |  | M80 A   | * use Fuse only                          | 70 A *   | 16                                  | 6     |    |
| ESV373N06TXB                             |  | M100 A  | * use Fuse only                          | 90 A *   | 16                                  | 4     |    |
| ESV453N06TXB                             |  | M125 A  | * use Fuse only                          | 110 A *  | 25                                  | 2     |    |



### Notes for Fuse and Cable Table:

- (1) Installations with high fault current due to large supply mains may require a type D circuit breaker.
- (2) UL Class CC or T fast-acting current-limiting type fuses, 200,000 AIC, preferred. Bussman KTK-R, JJJ or JJS or equivalent.
- (3) Thermomagnetic type breakers preferred.

- 11th digit of part number: F = Integral EMC Filter  
L = Integral EMC Filter and Integrated Disconnect Switch (NEMA 4X/IP65 Models only)  
M = Integrated Disconnect Switch (NEMA 4X/IP65 Models only)  
X = No EMC Filter/ No Disconnect Switch
- \* = Last digit of part number: C = N4X Indoor only (convection cooled)  
E = N4X Indoor/Outdoor (convection cooled)  
D = N4X Indoor only (fan cooled)  
F = N4X Indoor/Outdoor (fan cooled)

Observe the following when using Ground Fault Circuit Interrupters (GFCIs):

- Installation of GFCI only between supplying mains and controller.
- The GFCI can be activated by:
  - capacitive leakage currents between the cable screens during operation (especially with long, screened motor cables)
  - connecting several controllers to the mains at the same time
  - RFI filters

### 3.2.3 Control Terminals

#### Control Terminal Strip for 0.33 - 10 HP (0.25 - 7.5 kW):

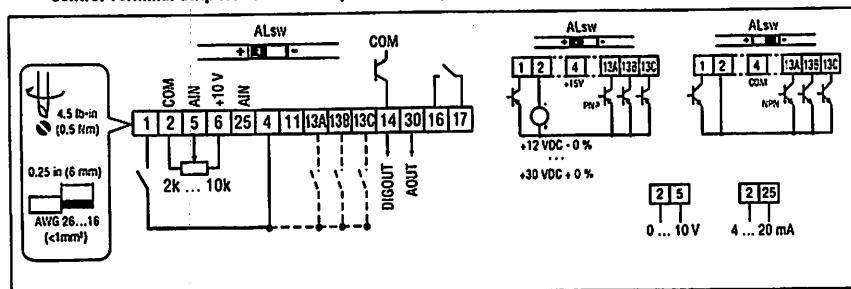

#### Control Terminal Strip for 15HP (11 kW) and Greater Drives:

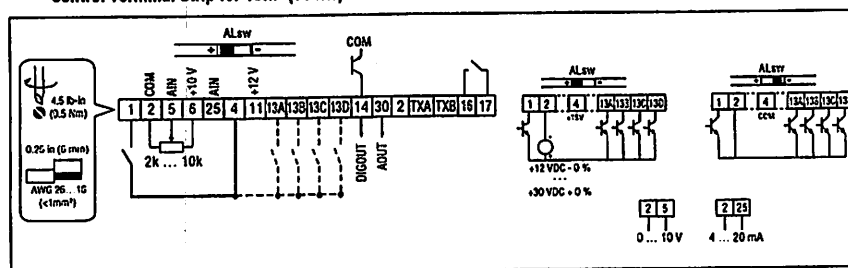

#### NOTE

Control and communications terminals provide basic insulation when the drive is connected to a power system rated up to 300V between phase to ground (PE) and the applied voltage on terminals 16 and 17 is less than 250 VAC between phase to phase and ground (PE).



## Installation

### Control Terminal Strip Descriptions

| Terminal | Description                                  | Important                                       |
|----------|--|---|
| 1        | Digital Input: Start/Stop                    | input resistance = 4.3k $\Omega$                |
| 2        | Analog Common                                |   |
| 5        | Analog Input: 0...10 VDC                     | input resistance: >50 k $\Omega$                |
| 6        | Internal DC supply for speed pot             | +10 VDC, max. 10 mA                             |
| 25       | Analog Input: 4...20 mA                      | input resistance: 250 $\Omega$                  |
| 4        | Digital Reference/Common                     | +15 VDC / 0 VDC, depending on assertion level   |
| 11       | Internal DC supply for external devices      | +12 VDC, max. 50 mA                             |
| 13A      | Digital Input: Configurable with P121        | input resistance = 4.3k $\Omega$                |
| 13B      | Digital Input: Configurable with P122        |   |
| 13C      | Digital Input: Configurable with P123        |   |
| 13D*     | Digital Input: Configurable with P124        |   |
| 14       | Digital Output: Configurable with P142, P144 | DC 24 V / 50 mA; NPN                            |
| 30       | Analog Output: Configurable with P150...P155 | 0...10 VDC, max. 20 mA                          |
| 2*       | Analog Common                                |   |
| TXA*     | RS485 TxA                                    |   |
| TXB*     | RS485 TxB                                    |   |
| 16       | Relay output: Configurable with P140, P144   | AC 250 V / 3 A                                  |
| 17       |  | DC 24 V / 2 A ... 240 V / 0.22 A, non-inductive |

\* = Terminal is part of the terminal strip for the 15HP (11kW) and higher models only.

#### Assertion level of digital inputs

The digital inputs can be configured for active-high or active-low by setting the Assertion Level Switch (ALsw) and P120. If wiring to the drive inputs with dry contacts or with PNP solid state switches, set the switch and P120 to "High" (+). If using NPN devices for inputs, set both to "Low" (-). Active-high (+) is the default setting.

HIGH = +12 ... +30 V  
LOW = 0 ... +3 V



#### NOTE

An F\_AL fault will occur if the Assertion Level switch (ALsw) position does not match the parameter P120 setting and P100 or any of the digital inputs (P121...P124) is set to a value other than 0.



## 4 Commissioning

### 4.1 Local Keypad & Display

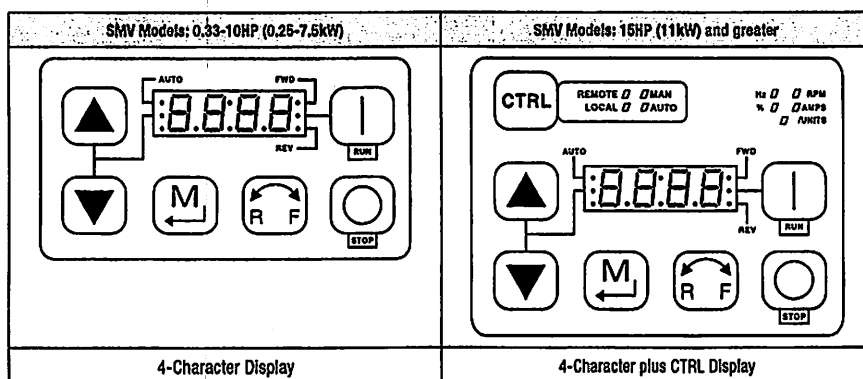

|                |  |
|----------------|--|
| <b>Display</b> | <b>START BUTTON</b>  |
|                | In Local Mode (P100 = 0, 4, 6), this button will start the drive.  |
|                | <b>STOP BUTTON</b>   |
|                | Stops the drive, regardless of which mode the drive is in.<br><b>WARNING!</b><br>When JOG is active, the STOP button will not stop the drive!  |
|                | <b>ROTATION</b>  |
|                | In Local Mode (P100 = 0, 4, 6), this selects the motor rotation direction:<br>- The LED for the present rotation direction (FWD or REV) will be on<br>- Press R/F; the LED for the opposite rotation direction will blink<br>- Press M within 4 seconds to confirm the change<br>- The blinking direction LED will turn on, and the other LED will turn off<br><br>When rotation direction is changed while the drive is running, the commanded direction LED will blink until the drive is controlling the motor in the selected direction.<br>Rotation is set in P112. When P112 = 0, rotation is forward only. When P112 = 1 rotation is forward and reverse. |
|                | <b>MODE</b>  |
|                | Used to enter/exit the Parameter Menu when programming the drive and to enter a changed parameter value.   |
|                | <b>UP AND DOWN BUTTONS</b>   |
|                | Used for programming and can also be used as a reference for speed, PID setpoint, or torque setpoint.<br>When the ▲ and ▼ buttons are the active reference, the middle LED on the left side of the display will be on.   |
|                |  |



## Commissioning

|   |  |                 |   |                          |
|---|--|-----------------|---|--------------------------|
| Display   | INDICATING LEDs (on 4-character display)   |                 |   |                          |
|   | FWD LED: Indicate the present rotation direction is forward. Refer to ROTATION description above.  |                 |   |                          |
|   | REV LED: Indicate the present rotation direction is reverse. Refer to ROTATION description above.  |                 |   |                          |
|   | AUTO LED: Indicates that the drive has been put into Auto mode from one of the TB13 inputs (P121...P124 set to 1...7). Indicates that PID mode is active (if PID mode is enabled). Indicates that sequencer mode is active (if sequencer mode is enabled). |                 |   |                          |
|   | RUN LED: Indicates that the drive is running.  |                 |   |                          |
|   | ▲ ▼ LED: Indicates that the ▲ ▼ are the active reference.  |                 |   |                          |
|   | <b>NOTE</b><br>If the keypad is selected as the auto reference (P121...P124 is 6) and the corresponding TB-13 input is closed, the AUTO LED and ▲ ▼ LEDs will both be on.  |                 |   |                          |
| <b>FUNCTIONS THAT FOLLOW ARE APPLICABLE TO SMV DRIVES 15HP (11kW) AND HIGHER</b>                            |  |                 |   |                          |
| CTRL  | <b>CTRL</b>  |                 |   |                          |
|   | The CTRL pushbutton selects the start and speed reference control sources for the drive.   |                 |   |                          |
|   | Press  mode button to accept the new control mode selection.   |                 |   |                          |
|   | <b>CTRL LEDs</b>   |                 | <b>START CONTROL</b>  | <b>REFERENCE CONTROL</b> |
|   |  | [LOCAL] [MAN]   | Keypad  | P101 Settings            |
|   |  | [LOCAL] [AUTO]  | Keypad  | Terminal 13x Settings    |
|   |  | [REMOTE] [MAN]  | Terminal Strip  | P101 Settings            |
|   |  | [REMOTE] [AUTO] | Terminal Strip  | Terminal 13x Settings    |
|   | If P100 = 6 the CTRL button is used to toggle start control between the terminal strip [REMOTE] and the keypad [LOCAL]   |                 | - REM/LOC LED indicating the present start control source is ON<br>- Press [CTRL]; the LED for other start control source will blink<br>- Press [M] within 4 sec to confirm the change<br>- Blinking LED will turn ON (the other LED will turn OFF) |                          |
|   | If P113 = 1 the CTRL button is used to toggle reference control between the TB-13x setup [AUTO] and P101 [MANUAL]  |                 | - AUT/MAN LED indicating present reference control is ON<br>- Press [CTRL]; the other reference control will blink<br>- Press [M] within 4 sec to confirm change<br>- Blinking LED will turn ON (the other LED will turn OFF)                       |                          |
| If P100 = 6 and P113 = 1, it is possible to change the start and reference control sources at the same time |  |                 |   |                          |

## Commissioning



|         |  |  |
|---------|--|--|
| Display | <b>START CONTROL</b>   |  |
|         | The REMOTE/LOCAL LEDs indicate the current start control source. If the start control source is a remote keypad or the network, then both LEDs will be OFF.  |  |
|         | <b>REFERENCE CONTROL</b>   |  |
|         | The AUTO/MANUAL LEDs indicate the current reference control source.  |  |
|         | IF P113 = 0 or 2, the AUTO/MANUAL LEDs will match the AUTO LED on the 4-character display. IF P113 = 0 and no AUTO reference has been setup on the terminal strip, the MANUAL LED will turn ON and the AUTO LED will turn OFF.   |  |
|         | IF P113 = 1, the AUTO/MANUAL LEDs show the commanded reference control source as selected by the [CTRL] button. If the [CTRL] button is used to set the reference control source to AUTO but no AUTO reference has been setup on the terminal strip, reference control will follow P101 but the AUTO LED will remain ON. |  |
|         | <b>UNITS LEDs</b>  |  |
|         | HZ: current display value is in Hz   | In Speed mode, if P178 = 0 then HZ LED will be ON. If P178 > 0, the Units LEDs follow the setting of P177 when the drive is in run (non-programming) mode.<br><br>In Torque mode, the HZ LED will be ON when the drive is in run (non-programming) mode.<br><br>In Pid mode, the Units LEDs follow the setting of P203 when the drive is in run (non-programming) mode.<br>If P179 > 0, the Units LEDs will show the unit of the diagnostic parameter that is being displayed. |
|         | %: current display value is in %   |  |
|         | RPM: current display value is in RPM   |  |
|         | AMPS: current display value is in Amps   |  |
|         | /UNITS current display value is a per unit (i.e./sec, /min, /hr, etc.)   |  |

## 4.2 Drive Display and Modes of Operation

### Speed Mode Display

In the standard mode of operation, the drive frequency output is set directly by the selected reference (keypad, analog reference, etc.). In this mode, the drive display will show the drive's output frequency.

### PID Mode Display

When the PID mode is enabled and active, the normal run display shows the actual PID setpoint. When PID mode is not active, the display returns to showing the drive's output frequency.

### Torque Mode Display

When the drive is operating in Vector Torque mode, the normal run display shows the drive's output frequency.

### Alternate (Run-Screen) Display

When P179 (Run Screen Display) is set to a value other than 0, one of the diagnostic parameters (P501...P599) is displayed. Example: if P179 is set to 1, then diagnostic parameter P501 (Software version) is displayed. If P179 =2, then P502 (Drive ID) is displayed.





## Commissioning

### 4.3 Parameter Setting

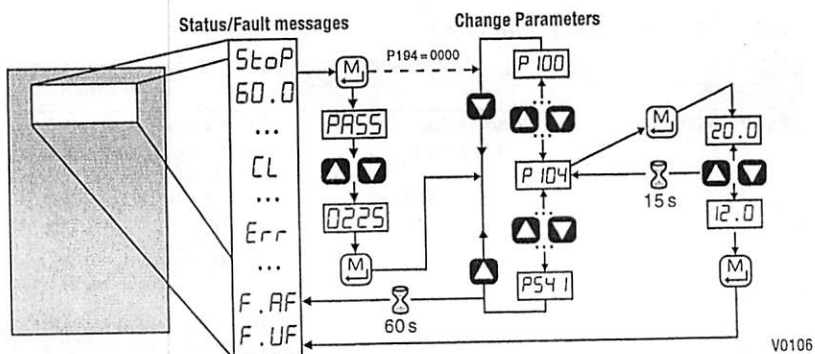

### 4.4 Electronic Programming Module (EPM)

The EPM contains the drives operational memory. Parameter settings are stored in the EPM and setting changes are made to the "User settings" in the EPM.

An optional EPM Programmer (model EEP1RA) is available that allows:

- An EPM to be copied directly to another EPM.
- An EPM to be copied to the memory of the EPM Programmer.
- Stored files can be modified in the EPM Programmer.
- Stored files can be copied to another EPM.



EPM Module  
in SMV Drive

As the EPM Programmer is battery operated, parameter settings can be copied to an EPM and inserted into a drive without power being applied to the drive. This means that the drive will be fully operational with the new settings on the next application of power.

Additionally, when the drives parameter settings are burned into an EPM with the EPM Programmer, the settings are saved in two distinct locations; the "User settings" and the "OEM default settings". While the User settings can be modified in the drive, the OEM settings cannot. Thus, the drive can be reset not only to the "factory" drive default settings (shown in this manual), but can be set to the Original Machine settings as programmed by the OEM.

The user area contents of the EPM are what are copied into the OEM space by the EPM programmer. When parameter modifications are made to the drive and then a copy made via the EPM Programmer, these are the settings that will be available by the OEM selections from P199. The EPM Programmer is the only way to load the OEM area of the EPM. While the EPM can be removed for copying or to use in another drive, it must be installed for the drive to operate (a missing EPM will trigger an F\_F I fault)

## Commissioning



### 4.5 Parameter Menu

#### 4.5.1 Basic Setup Parameters

| Code                                |                           | Possible Settings |  | IMPORTANT  |
|-------------------------------------|---------------------------|-------------------|--|--|
| No.                                 | Name                      | Default           | Selection  |  |
| P 100                               | Start Control Source      | 0                 | 0 Local Keypad   | Use RUN button on front of drive to start  |
|                                     |                           |                   | 1 Terminal Strip   | Use start/stop circuit wired into the terminal strip. Refer to section 3.2.3   |
|                                     |                           |                   | 2 Remote Keypad Only   | Use RUN button on optional Remote Keypad to start  |
|                                     |                           |                   | 3 Network Only   | <ul style="list-style-type: none"> <li>Start command must come from network (Modbus, CANopen, etc)</li> <li>SMV models &lt;15HP (11kW) require optional communication module (refer to the network module documentation).</li> <li>Must also set one of the TB-13 inputs to 9 (Network Enable); see P121...P124</li> </ul> |
|                                     |                           |                   | 4 Terminal Strip or Local Keypad   | Allows start control to be switched between terminal strip and local keypad using one of the TB-13 inputs. See note below.   |
|                                     |                           |                   | 5 Terminal Strip or Remote Keypad  | Allows start control to be switched between terminal strip and optional remote keypad using one of the TB-13 inputs. See Note below  |
|                                     |                           |                   | 6 CTRL button select   | Allows start control to be switched between terminal strip and local keypad using the CTRL button.<br><b>NOTE:</b> P100 Selection 6 is applicable to SMV 15HP (11kW) and higher models only.   |
|                                     |                           |                   | <b>WARNING!</b><br>P100 = 0 disables TB-1 as a STOP input! STOP circuitry may be disabled if parameters are reset back to defaults (see P199)  |  |
|                                     |                           |                   | <b>NOTE</b> <ul style="list-style-type: none"> <li>P100 = 4, 5: To switch between control sources, one of the TB-13 inputs (P121...P124) must be set to 08 (Control Select); TB-13x OPEN (or not configured); Terminal strip control</li> <li>TB-13x CLOSED: Local (P100 = 4) or Remote (P100 = 5) keypad</li> <li>P100 = 0, 1, 4, 6: Network can take control if P121...P124 = 9 and the corresponding TB-13x input is CLOSED.</li> <li>The STOP button on the front of the drive is always active except in JOG mode.</li> <li>TB-1 is an active STOP input if P100 is set to a value other than 0.</li> <li>An <b>F<sub>RL</sub></b> fault will occur if the Assertion Level switch (ALsw) position does not match the P120 setting and P100 is set to a value other than 0.</li> </ul> |  |
| P 101                               | Standard Reference Source | 0                 | 0 Keypad (Local or Remote)   | Selects the default speed or torque reference when no Auto Reference is selected using the TB-13 inputs.   |
|                                     |                           |                   | 1 0-10 VDC   |  |
|                                     |                           |                   | 2 4-20 mA  |  |
|                                     |                           |                   | 3 Preset #1 (P131)   |  |
|                                     |                           |                   | 4 Preset #2 (P132)   |  |
|                                     |                           |                   | 5 Preset #3 (P133)   |  |
|                                     |                           |                   | 6 Network  |  |
|                                     |                           |                   | 7 Preset Sequence Segment #1 (P710)  | Selections 7, 8 & 9 are not valid for PID setpoint or torque reference.  |
|                                     |                           |                   | 8 Preset Sequence Segment #2 (P715)  |  |
| 9 Preset Sequence Segment #3 (P720) |                           |                   |  |  |



## Commissioning

| Code                 |                         | Possible Settings  |   |      | IMPORTANT  |
|----------------------|-------------------------|--|---|------|--|
| No.                  | Name                    | Default  | Selection   |      |  |
| P 102                | Minimum Frequency       | 0.0  | 0.0 (Hz)  | P103 | <ul style="list-style-type: none"> <li>P102, P103 are active for all speed references</li> <li>When using an analog speed reference, also see P160, P161</li> </ul>  |
| P 103                | Maximum Frequency       | 60.0   | 7.5 (Hz)  | 500  |  |
|                      |                         | <p><b>i</b> NOTE</p> <ul style="list-style-type: none"> <li>P103 cannot be set below Minimum Frequency (P102)</li> <li>To set P103 above 120 Hz:               <ul style="list-style-type: none"> <li>- Scroll up to 120 Hz; display shows H Fr (flashing).</li> <li>- Release ▽ button and wait one second.</li> <li>- Press ▽ button again to continue increasing P103.</li> </ul> </li> </ul> |   |      |  |
|                      |                         | <p><b>!</b> WARNING!</p> <p>Consult motor/machine manufacturer before operating above rated frequency. Overspeeding the motor/machine may cause damage to equipment and injury to personnel!</p>   |   |      |  |
| P 104                | Acceleration Time 1     | 20.0   | 0.0 (s)   | 3600 | <ul style="list-style-type: none"> <li>P104 = time of frequency change from 0 Hz to P167 (base frequency)</li> <li>P105 = time of frequency change from P167 to 0 Hz</li> <li>For S-ramp accel/decel, adjust P106</li> </ul>         |
| P 105                | Deceleration Time 1     | 20.0   | 0.0 (s)   | 3600 |  |
|                      |                         | <p><b>i</b> EXAMPLE: IF P103 = 120 Hz, P104 = 20.0 s and P167 (base frequency) = 60 Hz; then the rate of frequency change from 0 Hz to 120 Hz = 40.0 s</p>   |   |      |  |
| P 106                | S-Ramp Integration Time | 0.0  | 0.0 (s)   | 50.0 | <ul style="list-style-type: none"> <li>P106 = 0.0: Linear accel/decel ramp</li> <li>P106 &gt; 0.0: Adjusts S-ramp curve for smoother ramp</li> </ul>   |
| P 107 <sup>(1)</sup> | Line Voltage Selection  | 1*   | 0 Low (120, 200, 400, 480VAC)<br>1 High (120, 240, 480, 600VAC) |      | <ul style="list-style-type: none"> <li>The default setting is 1 for all drives except when using "Reset to 50Hz default settings" (Parameter P199, selection 4) with 480V models. In this case, the default setting is 0.</li> </ul> |
| P 108                | Motor Overload          | 100  | 30 (%)  | 100  | $P108 = \frac{\text{motor current rating}}{\text{SMV output rating}} \times 100$<br>Example: if motor = 3amps and SMV = 4amps, then P108 = 75%   |
|                      |                         | <p><b>i</b> NOTE</p> <p>Do not set above rated motor current as listed on the motor dataplate. The motor thermal overload function of the SMV is UL approved as a motor protection device. Cycling power after an overload fault could result in significantly reducing the motor life.</p>  |   |      |  |
| P 109                | Motor Overload Type     | 0  | 0 Speed Compensation  |      |  |
|                      |                         | <p>1 No Speed Compensation</p> <p>Example: Motor is cooled by forced ventilation as opposed to shaft mounted, self cooling fans.</p>   |   |      |  |

(1) Any changes to this parameter will not take effect until the drive is stopped.

## Commissioning



| Code   |              | Possible Settings |   | IMPORTANT  |
|--|--------------|-------------------|---|--|
| No.  | Name         | Default           | Selection   |  |
| P110   | Start Method | 0                 | 0 Normal  | Drive will automatically start when power is applied.<br>When start command is applied, drive will apply DC braking according to P174, P175 prior to starting the motor<br>Drive will automatically restart after faults, or when power is applied.<br>Combines settings 2 and 3<br>• Drive will automatically restart after faults, or when power is applied.<br>• After 3 failed attempts, drive will Auto Restart with DC brake.<br>• P110 = 5, 7: Performs speed search, starting at Max Frequency (P103)<br>• P110 = 6, 8: Performs speed search, starting at the last output frequency prior to faulting or power loss<br>• If P111 = 0, a flying START is performed when a start command is applied.<br>• P110 = 7,8: Utilizes P280/281 to set Max Current Level and Decel Time for restart |
|  |              |                   | 1 Start on Power-up   |  |
|  |              |                   | 2 Start with DC Brake   |  |
|  |              |                   | 3 Auto Restart  |  |
|  |              |                   | 4 Auto Restart with DC Brake  |  |
|  |              |                   | 5 Flying Start/Restart - Type 1   |  |
|  |              |                   | 6 Flying Start/Restart - Type 1   |  |
|  |              |                   | 7 Flying Start /Restart - Type 2 for 2-pole motors requiring a flying restart   |  |
| 8 Flying Start/Restart - Type 2 for 2-pole motors requiring a flying restart   |              |                   |   |  |
|  |              |                   | <b>NOTE</b> <ul style="list-style-type: none"> <li>• P110 = 0, 2: Start command must be applied at least 2 seconds after power-up; <b>F<sub>UF</sub></b> fault will occur if start command is applied too soon.</li> <li>• P110 = 1, 3...6: For automatic start/restart, the start source must be the terminal strip and the start command must be present.</li> <li>• P110 = 2, 4...6: If P175=999.9, dc braking will be applied for 15s.</li> <li>• P110 = 3...6: Drive will attempt 5 restarts; if all restart attempts fail, drive displays <b>LC</b> (fault lockout) and requires manual reset.</li> <li>• P110 = 5, 6: If drive cannot catch the spinning motor, drive will trip into <b>F<sub>RF</sub></b> fault.</li> <li>• P110 = 5, 6: If drive trips into <b>F<sub>DF</sub></b> fault, try P110 = 7 or 8.</li> </ul> |  |
| <b>WARNING!</b><br>Automatic starting/restarting may cause damage to equipment and/or injury to personnel! Automatic starting/restarting should only be used on equipment that is inaccessible to personnel. |              |                   |   |  |
| P111   | Stop Method  | 0                 | 0 Coast   | Drive's output will shut off immediately upon a stop command, allowing the motor to coast to a stop<br>The drive's output will shut off and then the DC Brake will activate (refer to P174, P175)<br>The drive will ramp the motor to a stop according to P105 or P126.<br>The drive will ramp the motor to 0 Hz and then the DC Brake will activate (refer to P174, P175)   |
|  |              |                   | 1 Coast with DC Brake   |  |
|  |              |                   | 2 Ramp  |  |
|  |              |                   | 3 Ramp with DC Brake  |  |
| P112   | Rotation     | 0                 | 0 Forward Only  | If PID mode is enabled, reverse direction is disabled (except for Jog).  |
|  |              |                   | 1 Forward and Reverse   |  |







## Commissioning

| Code |                                      | Possible Settings  |   | IMPORTANT   |
|------|--------------------------------------|--|---|---|
| No.  | Name                                 | Default  | Selection   |   |
| P113 | Auto/Manual Control                  | 0  | 0 Terminal Strip Control                                      | The reference is dictated by the settings and state of the TB-13x terminals. If no AUTO reference has been setup on the terminal strip then reference control is dictated by P101.  |
|      |                                      |  | 1 Auto/Manual (CTRL button select)                            | Allows the reference to be switched between auto and manual using the CTRL pushbutton on the drive keypad. If the CTRL pushbutton has selected AUTO reference but no AUTO reference has been setup on the terminal strip, then reference control is dictated by P101. |
|      |                                      |  | 2 Manual Control Only   | Reference is dictated by P101 regardless of any AUTO source that may be selected by the TB-13x terminals.   |
|      |                                      |  NOTE | P113 is applicable to SMV 15HP (11kW) and higher models only. |   |
| P115 | MOP Speed Initialization at Power-Up | 0  | 0 Set to last MOP speed at power up                           | Output frequency at power-up = last MOP speed   |
|      |                                      |  | 1 Set to 0.0Hz at power up                                    | Output frequency at power-up = 0Hz  |
|      |                                      |  | 2 Set to Preset #3 (P133) at power up                         | Output frequency at power-up = P133   |

## Commissioning



### 4.5.2 I/O Setup Parameters

| Code  |  | Possible Settings |  | IMPORTANT  |
|---|--|-------------------|--|--|
| No.   | Name   | Default           | Selection  |  |
| P 120   | Assertion Level  | 2                 | 1 Low<br>2 High  | P120 and the Assertion Level switch must both match the desired assertion level unless P100, P121...P124 are all set to 0. Otherwise an F.AL fault will occur.   |
| P 121   | TB-13A Digital Input   | 0                 | 0 None<br>1 AUTO Reference: 0-10 VDC<br>2 AUTO Reference: 4-20 mA  | Disables input<br>For frequency mode, see P160...P161,<br>For PID mode, see P204...P205,<br>For vector torque mode, see P330   |
| P 122   | TB-13B Digital Input<br>(Priority > TB13A)<br>Same as TB13A except:<br>3 = Preset #2<br>23 = Seq Seg, #2   |                   | 3 AUTO Reference: Preset #1<br>* 13D: 3 = Reserved   | For frequency mode see P131...P137,<br>For PID mode, see P231...P233,<br>For torque mode see, P331...P333  |
| P 123   | TB-13C Digital Input<br>(Priority > TB13B, A)<br>Same as TB13A except:<br>3 = Preset #3<br>23 = Seq Seg, #4  |                   | 4 AUTO Reference: MOP Up<br>5 AUTO Reference: MOP Down<br>6 AUTO Reference: Keypad<br>7 AUTO Reference: Network<br>8 Control Select  | <ul style="list-style-type: none"> <li>Normally open: Close input to increase or decrease speed, PID or torque setpoint.</li> <li>MOP Up is not active while in STOP</li> </ul>  |
| P 124   | TB-13D* Digital Input<br>(Priority > TB13C, B, A)<br>Same as TB13A except:<br>3 = Preset #4<br>23 = Seq Seg, #8<br><br><br>NOTE: P124 is applicable to SMV 15HP (11kW) and higher models only |                   | 9 Network Enable<br>10 Reverse Rotation<br>11 Start Forward<br>12 Start Reverse<br>13 Run Forward<br>14 Run Reverse<br>15 Jog Forward<br>16 Jog Reverse<br>17 Accel/Decel #2<br>18 DC Brake<br>19 Auxiliary Ramp to Stop<br>20 Clear Fault<br>21 External Fault F_EF<br>22 Inverse External Fault F_EF<br>23 AUTO Ref: Sequence Segment #1<br>24 Start Sequence<br>25 Step Sequence<br>26 Suspend Sequence | Use when P100 = 4, 5 to switch between terminal strip control and local or remote keypad control. Required to start the drive through the network. Open = Forward Closed = Reverse<br>Refer to Note for typical circuit<br>Refer to Note for typical circuit<br>Jog Forward speed = P134<br>Jog Reverse speed = P135<br> Active even if P112 = 0<br>Refer to P125, P126<br>Refer to P174; close input to override P175<br>Normally closed: Opening input will ramp drive to STOP according to P127, even if P111 is set to Coast (0 or 1).<br>Close to reset fault<br>Normally closed circuit; open to trip<br>Normally open circuit; close to trip<br>Works in Speed Mode only<br>Transition from non-asserted to asserted state |
|  | <b>WARNING</b><br>Jog overrides all STOP commands! To stop the drive while in Jog mode, the Jog input must be deactivated or a fault condition induced.  |                   |  |  |
|  | <b>WARNING</b><br>If the input defined to "Start Sequence" is opened during a sequence, the drive will exit sequencer mode and will run at the specified standard or alternate speed source (dependent on drive configuration).  |                   |  |  |



## Commissioning

| Code          |  | Possible Settings  |  |      |      | IMPORTANT  |              |     |     |     |     |   |   |    |    |    |   |    |   |    |    |   |    |    |   |    |   |   |   |    |    |               |    |    |    |   |   |   |    |   |    |   |    |   |   |    |   |   |   |   |    |               |    |   |    |   |               |    |    |   |   |
|---------------|--|--|--|------|------|--|--------------|-----|-----|-----|-----|---|---|----|----|----|---|----|---|----|----|---|----|----|---|----|---|---|---|----|----|---------------|----|----|----|---|---|---|----|---|----|---|----|---|---|----|---|---|---|---|----|---------------|----|---|----|---|---------------|----|----|---|---|
| No.           | Name   | Default  | Selection  |      |      |  |              |     |     |     |     |   |   |    |    |    |   |    |   |    |    |   |    |    |   |    |   |   |   |    |    |               |    |    |    |   |   |   |    |   |    |   |    |   |   |    |   |   |   |   |    |               |    |   |    |   |               |    |    |   |   |
| <b>i</b>      | <b>NOTE</b> <ul style="list-style-type: none"> <li>When input is activated, settings 1...7 override P101</li> <li>When TB-13A...TB-13D are configured for Auto References other than MOP, TB-13D overrides TB-13C, TB-13C overrides TB-13B and TB-13B overrides TB-13A. Any other Auto Reference will have priority over MOP.</li> <li>Settings 10...14 are only valid in Terminal Strip mode (P100 = 1, 4, 5, 6)</li> <li>If Start/Run/Jog Forward and Start/Run/Jog Reverse are both activated, drive will STOP</li> <li>If Jog input is activated while drive is running, the drive will enter Jog mode; when Jog input is deactivated, drive will STOP</li> <li>An <b>F..RL</b> fault will occur if the Assertion Level switch (ALsw) position does not match the P120 setting and any of the digital inputs (P121...P124) are set to a value other than 0.</li> <li>An <b>F..I L</b> fault will occur under the following conditions:               <ul style="list-style-type: none"> <li>- TB-13A...TB-13D settings are duplicated (each setting, except 0, 3 and 23, can only be used once)</li> <li>- One input is set to "MOP Up" and another is not set to "MOP Down", or vice-versa.</li> <li>- One input is set to 10 and another input is set to 11...14.</li> <li>- One input is set to 11 or 12 and another input is set for 13 or 14.</li> </ul> </li> <li>Typical control circuits are shown below:               <ul style="list-style-type: none"> <li>- If any input is set to 10, 12 or 14, P112 must be set to 1 for Reverse action to function.</li> </ul> </li> </ul> |  |  |      |      |  |              |     |     |     |     |   |   |    |    |    |   |    |   |    |    |   |    |    |   |    |   |   |   |    |    |               |    |    |    |   |   |   |    |   |    |   |    |   |   |    |   |   |   |   |    |               |    |   |    |   |               |    |    |   |   |
|               | Run / Stop<br>with Direction<br>P121 = 10<br><br>  | Start Forward /<br>Start Reverse<br>P121 = 11, P122 = 12<br><br> | Run Forward /<br>Run Reverse<br>P121 = 13, P122 = 14<br><br> |      |      |  |              |     |     |     |     |   |   |    |    |    |   |    |   |    |    |   |    |    |   |    |   |   |   |    |    |               |    |    |    |   |   |   |    |   |    |   |    |   |   |    |   |   |   |   |    |               |    |   |    |   |               |    |    |   |   |
| P 125         | Acceleration Time 2  | 20.0   | 0.0  | {s}  | 3600 | <ul style="list-style-type: none"> <li>Selected using TB-13A...TB-13D (P121...P124 = 17)</li> <li>For S-ramp accel/decel, adjust P106</li> </ul>   |              |     |     |     |     |   |   |    |    |    |   |    |   |    |    |   |    |    |   |    |   |   |   |    |    |               |    |    |    |   |   |   |    |   |    |   |    |   |   |    |   |   |   |   |    |               |    |   |    |   |               |    |    |   |   |
| P 126         | Deceleration Time 2  | 20.0   | 0.0  | {s}  | 3600 |  |              |     |     |     |     |   |   |    |    |    |   |    |   |    |    |   |    |    |   |    |   |   |   |    |    |               |    |    |    |   |   |   |    |   |    |   |    |   |   |    |   |   |   |   |    |               |    |   |    |   |               |    |    |   |   |
| P 127         | Deceleration Time for Auxiliary Ramp to Stop   | 20.0   | 0.0  | {s}  | 3600 | <ul style="list-style-type: none"> <li>Selected using TB-13A...TB-13D (P121...P124 = 19).</li> <li>For S-ramp accel/decel, adjust P106</li> <li>Once executed, this ramp time has priority over P105 and P126.</li> </ul>  |              |     |     |     |     |   |   |    |    |    |   |    |   |    |    |   |    |    |   |    |   |   |   |    |    |               |    |    |    |   |   |   |    |   |    |   |    |   |   |    |   |   |   |   |    |               |    |   |    |   |               |    |    |   |   |
| P 129         | Automatic Accel/Decel rate switch threshold  | 0.0  | 0.0  | {Hz} | 1000 | If Actual Frequency < P129 Use Accel/decel time #2 (P125/P126)<br>If Actual Frequency > P129 Use Accel/decel time #1 (P104/P105)   |              |     |     |     |     |   |   |    |    |    |   |    |   |    |    |   |    |    |   |    |   |   |   |    |    |               |    |    |    |   |   |   |    |   |    |   |    |   |   |    |   |   |   |   |    |               |    |   |    |   |               |    |    |   |   |
| P 131         | Preset Speed #1  | 0.0  | 0.0  | {Hz} | 500  | <table border="1" style="width: 100%; border-collapse: collapse; text-align: center;"> <thead> <tr> <th>PRESET SPEED</th> <th>13A</th> <th>13B</th> <th>13C</th> <th>13D</th> </tr> </thead> <tbody> <tr><td>1</td><td>X</td><td>--</td><td>--</td><td>--</td></tr> <tr><td>2</td><td>--</td><td>X</td><td>--</td><td>--</td></tr> <tr><td>3</td><td>--</td><td>--</td><td>X</td><td>--</td></tr> <tr><td>4</td><td>X</td><td>X</td><td>--</td><td>--</td></tr> <tr><td>4 (alternate)</td><td>--</td><td>--</td><td>--</td><td>X</td></tr> <tr><td>5</td><td>X</td><td>--</td><td>X</td><td>--</td></tr> <tr><td>6</td><td>--</td><td>X</td><td>X</td><td>--</td></tr> <tr><td>7</td><td>X</td><td>X</td><td>X</td><td>--</td></tr> <tr><td>8 (alternate)</td><td>--</td><td>X</td><td>--</td><td>X</td></tr> <tr><td>8 (alternate)</td><td>--</td><td>--</td><td>X</td><td>X</td></tr> </tbody> </table> <ul style="list-style-type: none"> <li>Speed setting is used by P158</li> <li>13D available on 15HP (11kW) &amp; higher drives.</li> </ul> | PRESET SPEED | 13A | 13B | 13C | 13D | 1 | X | -- | -- | -- | 2 | -- | X | -- | -- | 3 | -- | -- | X | -- | 4 | X | X | -- | -- | 4 (alternate) | -- | -- | -- | X | 5 | X | -- | X | -- | 6 | -- | X | X | -- | 7 | X | X | X | -- | 8 (alternate) | -- | X | -- | X | 8 (alternate) | -- | -- | X | X |
| PRESET SPEED  | 13A  | 13B  | 13C  | 13D  |      |  |              |     |     |     |     |   |   |    |    |    |   |    |   |    |    |   |    |    |   |    |   |   |   |    |    |               |    |    |    |   |   |   |    |   |    |   |    |   |   |    |   |   |   |   |    |               |    |   |    |   |               |    |    |   |   |
| 1             | X  | --   | --   | --   |      |  |              |     |     |     |     |   |   |    |    |    |   |    |   |    |    |   |    |    |   |    |   |   |   |    |    |               |    |    |    |   |   |   |    |   |    |   |    |   |   |    |   |   |   |   |    |               |    |   |    |   |               |    |    |   |   |
| 2             | --   | X  | --   | --   |      |  |              |     |     |     |     |   |   |    |    |    |   |    |   |    |    |   |    |    |   |    |   |   |   |    |    |               |    |    |    |   |   |   |    |   |    |   |    |   |   |    |   |   |   |   |    |               |    |   |    |   |               |    |    |   |   |
| 3             | --   | --   | X  | --   |      |  |              |     |     |     |     |   |   |    |    |    |   |    |   |    |    |   |    |    |   |    |   |   |   |    |    |               |    |    |    |   |   |   |    |   |    |   |    |   |   |    |   |   |   |   |    |               |    |   |    |   |               |    |    |   |   |
| 4             | X  | X  | --   | --   |      |  |              |     |     |     |     |   |   |    |    |    |   |    |   |    |    |   |    |    |   |    |   |   |   |    |    |               |    |    |    |   |   |   |    |   |    |   |    |   |   |    |   |   |   |   |    |               |    |   |    |   |               |    |    |   |   |
| 4 (alternate) | --   | --   | --   | X    |      |  |              |     |     |     |     |   |   |    |    |    |   |    |   |    |    |   |    |    |   |    |   |   |   |    |    |               |    |    |    |   |   |   |    |   |    |   |    |   |   |    |   |   |   |   |    |               |    |   |    |   |               |    |    |   |   |
| 5             | X  | --   | X  | --   |      |  |              |     |     |     |     |   |   |    |    |    |   |    |   |    |    |   |    |    |   |    |   |   |   |    |    |               |    |    |    |   |   |   |    |   |    |   |    |   |   |    |   |   |   |   |    |               |    |   |    |   |               |    |    |   |   |
| 6             | --   | X  | X  | --   |      |  |              |     |     |     |     |   |   |    |    |    |   |    |   |    |    |   |    |    |   |    |   |   |   |    |    |               |    |    |    |   |   |   |    |   |    |   |    |   |   |    |   |   |   |   |    |               |    |   |    |   |               |    |    |   |   |
| 7             | X  | X  | X  | --   |      |  |              |     |     |     |     |   |   |    |    |    |   |    |   |    |    |   |    |    |   |    |   |   |   |    |    |               |    |    |    |   |   |   |    |   |    |   |    |   |   |    |   |   |   |   |    |               |    |   |    |   |               |    |    |   |   |
| 8 (alternate) | --   | X  | --   | X    |      |  |              |     |     |     |     |   |   |    |    |    |   |    |   |    |    |   |    |    |   |    |   |   |   |    |    |               |    |    |    |   |   |   |    |   |    |   |    |   |   |    |   |   |   |   |    |               |    |   |    |   |               |    |    |   |   |
| 8 (alternate) | --   | --   | X  | X    |      |  |              |     |     |     |     |   |   |    |    |    |   |    |   |    |    |   |    |    |   |    |   |   |   |    |    |               |    |    |    |   |   |   |    |   |    |   |    |   |   |    |   |   |   |   |    |               |    |   |    |   |               |    |    |   |   |
| P 132         | Preset Speed #2  | 0.0  | 0.0  | {Hz} | 500  |  |              |     |     |     |     |   |   |    |    |    |   |    |   |    |    |   |    |    |   |    |   |   |   |    |    |               |    |    |    |   |   |   |    |   |    |   |    |   |   |    |   |   |   |   |    |               |    |   |    |   |               |    |    |   |   |
| P 133         | Preset Speed #3  | 0.0  | 0.0  | {Hz} | 500  |  |              |     |     |     |     |   |   |    |    |    |   |    |   |    |    |   |    |    |   |    |   |   |   |    |    |               |    |    |    |   |   |   |    |   |    |   |    |   |   |    |   |   |   |   |    |               |    |   |    |   |               |    |    |   |   |
| P 134         | Preset Speed #4  | 0.0  | 0.0  | {Hz} | 500  |  |              |     |     |     |     |   |   |    |    |    |   |    |   |    |    |   |    |    |   |    |   |   |   |    |    |               |    |    |    |   |   |   |    |   |    |   |    |   |   |    |   |   |   |   |    |               |    |   |    |   |               |    |    |   |   |
| P 135         | Preset Speed #5  | 0.0  | 0.0  | {Hz} | 500  |  |              |     |     |     |     |   |   |    |    |    |   |    |   |    |    |   |    |    |   |    |   |   |   |    |    |               |    |    |    |   |   |   |    |   |    |   |    |   |   |    |   |   |   |   |    |               |    |   |    |   |               |    |    |   |   |
| P 136         | Preset Speed #6  | 0.0  | 0.0  | {Hz} | 500  |  |              |     |     |     |     |   |   |    |    |    |   |    |   |    |    |   |    |    |   |    |   |   |   |    |    |               |    |    |    |   |   |   |    |   |    |   |    |   |   |    |   |   |   |   |    |               |    |   |    |   |               |    |    |   |   |
| P 137         | Preset Speed #7  | 0.0  | 0.0  | {Hz} | 500  |  |              |     |     |     |     |   |   |    |    |    |   |    |   |    |    |   |    |    |   |    |   |   |   |    |    |               |    |    |    |   |   |   |    |   |    |   |    |   |   |    |   |   |   |   |    |               |    |   |    |   |               |    |    |   |   |
| P 138         | Preset Speed #8  | 0.0  | 0.0  | {Hz} | 500  |  |              |     |     |     |     |   |   |    |    |    |   |    |   |    |    |   |    |    |   |    |   |   |   |    |    |               |    |    |    |   |   |   |    |   |    |   |    |   |   |    |   |   |   |   |    |               |    |   |    |   |               |    |    |   |   |

## Commissioning



| Code                        |                           | Possible Settings |   | IMPORTANT  |
|-----------------------------|---------------------------|-------------------|---|--|
| No.                         | Name                      | Default           | Selection                                   |  |
| P 140                       | Relay Output<br>TB-16, 17 | 0                 | 0 None                                      | Disables the output  |
|                             |                           |                   | 1 Run                                       | Energizes when the drive is running  |
|                             |                           |                   | 2 Reverse                                   | Energizes when reverse rotation is active  |
|                             |                           |                   | 3 Fault                                     | De-energizes when the drive trips, or power is removed   |
|                             |                           |                   | 4 Inverse Fault                             | Energizes when the drive trips   |
|                             |                           |                   | 5 Fault Lockout                             | P110 = 3...6: De-energizes if all restart attempts fail  |
|                             |                           |                   | 6 At Speed                                  | Energizes when output frequency = commanded frequency  |
|                             |                           |                   | 7 Above Preset Speed #6                     | Energizes when output frequency > P136   |
|                             |                           |                   | 8 Current Limit                             | Energizes when motor current = P171  |
|                             |                           |                   | 9 Follower Loss (4-20 mA)                   | Energizes when 4-20 mA signal is < P164  |
|                             |                           |                   | 10 Loss of Load                             | Energizes when motor load drops below P145; Refer to P146 also   |
|                             |                           |                   | 11 Local Keypad Control Active              | Energizes when the selected source is active for start control   |
|                             |                           |                   | 12 Terminal Strip Control Active            |  |
|                             |                           |                   | 13 Remote Keypad Control Active             |  |
|                             |                           |                   | 14 Network Control Active                   |  |
|                             |                           |                   | 15 Standard Reference Active                | Energizes when P101 reference is active  |
|                             |                           |                   | 16 Auto Reference Active                    | Energizes when Auto Reference is activated using TB-13 input; refer to P121...P124                             |
|                             |                           |                   | 17 Sleep Mode Active                        | Refer to P240...P242   |
|                             |                           |                   | 18 PID Feedback < Min. Alarm                | Energizes when PID feedback signal < P214  |
|                             |                           |                   | 19 Inverse PID Feedback < Min. Alarm        | De-energizes when PID feedback signal < P214   |
|                             |                           |                   | 20 PID Feedback > Max Alarm                 | Energizes when PID feedback signal > P215  |
|                             |                           |                   | 21 Inverse PID Feedback > Max Alarm         | De-energizes when PID feedback signal > P215   |
|                             |                           |                   | 22 PID Feedback within Min/Max Alarm range  | Energizes when PID feedback signal is within the Min/Max Alarm range; refer to P214, P215                      |
|                             |                           |                   | 23 PID Feedback outside Min/Max Alarm range | Energizes when PID feedback signal is outside the Min/Max Alarm range; refer to P214, P215                     |
|                             |                           |                   | 24 Reserved                                 |  |
|                             |                           |                   | 25 Network Controlled                       | SMV models < 15HP (11kW) require an optional communication module (refer to the network module documentation). |
|                             |                           |                   | 26 Loss of 0-10V Input                      | Energizes when 0-10V signal is < P158  |
|                             |                           |                   | 27 Sequencer Controlled                     | State set in individual sequencer segments   |
|                             |                           |                   | 28 Sequencer Active                         |  |
|                             |                           |                   | 29 Sequencer Suspended                      |  |
|                             |                           |                   | 30 Sequence Done                            | End Sequence   |
| 31 Output Frequency = 0.0Hz | Output inactive           |                   |   |  |
| P 142                       | TB-14 Output              | 0                 | 0...23 (same as P140)                       |  |
|                             |                           |                   | 24 Dynamic Braking                          | For use with Dynamic Braking option  |
|                             |                           |                   | 25...31 (same as P140)                      |  |





## Commissioning

| Code   |                                  | Possible Settings  |  |                    | IMPORTANT   |  |             |                           |    |                           |   |               |     |               |     |                 |   |                 |     |   |   |                     |   |                    |    |                      |   |
|--|----------------------------------|--------------------|--|--------------------|-------------|--|-------------|---------------------------|----|---------------------------|---|---------------|-----|---------------|-----|-----------------|---|-----------------|-----|---|---|---------------------|---|--------------------|----|----------------------|---|
| No.  | Name                             | Default            | Selection  |                    |             |  |             |                           |    |                           |   |               |     |               |     |                 |   |                 |     |   |   |                     |   |                    |    |                      |   |
| P 144  | Digital Output Inversion         |                    | <table border="1"> <thead> <tr> <th>P144</th> <th>Invert P142</th> <th>Invert P140</th> </tr> </thead> <tbody> <tr> <td>0</td> <td>NO</td> <td>NO</td> </tr> <tr> <td>1</td> <td>NO</td> <td>YES</td> </tr> <tr> <td>2</td> <td>YES</td> <td>NO</td> </tr> <tr> <td>3</td> <td>YES</td> <td>YES</td> </tr> </tbody> </table>   |                    | P144        | Invert P142  | Invert P140 | 0                         | NO | NO                        | 1 | NO            | YES | 2             | YES | NO              | 3 | YES             | YES | <p>Used to invert the selections for P140 (Relay Output) and P142 (TB-14 Output).<br/>           EXAMPLE: When P140 = 6 (AT SPEED), the relay is energized when output frequency = commanded frequency. If P144=1 or 3, then P140 is inverted (INVERSE AT SPEED) and the relay is energized when the output frequency does not equal the command frequency.</p> |   |                     |   |                    |    |                      |   |
|  |                                  |                    | P144   | Invert P142        | Invert P140 |  |             |                           |    |                           |   |               |     |               |     |                 |   |                 |     |   |   |                     |   |                    |    |                      |   |
|  |                                  |                    | 0  | NO                 | NO          |  |             |                           |    |                           |   |               |     |               |     |                 |   |                 |     |   |   |                     |   |                    |    |                      |   |
| 1  | NO                               | YES                |  |                    |             |  |             |                           |    |                           |   |               |     |               |     |                 |   |                 |     |   |   |                     |   |                    |    |                      |   |
| 2  | YES                              | NO                 |  |                    |             |  |             |                           |    |                           |   |               |     |               |     |                 |   |                 |     |   |   |                     |   |                    |    |                      |   |
| 3  | YES                              | YES                |  |                    |             |  |             |                           |    |                           |   |               |     |               |     |                 |   |                 |     |   |   |                     |   |                    |    |                      |   |
| <p><b>i</b> NOTE<br/>           Inverting P140 or P142 when the parameter is set to NONE (0) will result in the output being energized continuously.</p>   |                                  |                    |  |                    |             |  |             |                           |    |                           |   |               |     |               |     |                 |   |                 |     |   |   |                     |   |                    |    |                      |   |
| <p><b>i</b> NOTE<br/>           For SMVector drives rated at 0.33 to 10 HP (0.25 to 7.5 kW), P144 is only available with software versions 3.0 and higher (refer to P501).</p>   |                                  |                    |  |                    |             |  |             |                           |    |                           |   |               |     |               |     |                 |   |                 |     |   |   |                     |   |                    |    |                      |   |
| P 145  | Loss of Load Threshold           | 0                  | 0  | (%)                | 200         | <p>P140, P142 = 10: Output will energize if motor load falls below the P145 value longer than the P146 time</p>  |             |                           |    |                           |   |               |     |               |     |                 |   |                 |     |   |   |                     |   |                    |    |                      |   |
| P 146  | Loss of Load Delay               | 0.0                | 0.0  | (s)                | 240.0       |  |             |                           |    |                           |   |               |     |               |     |                 |   |                 |     |   |   |                     |   |                    |    |                      |   |
| P 149  | Analog Output Offset             | 0.0                | 0  | (%)                | 100         |  |             |                           |    |                           |   |               |     |               |     |                 |   |                 |     |   |   |                     |   |                    |    |                      |   |
| P 150  | TB-30 Output                     | 0                  | <table border="1"> <tbody> <tr><td>0</td><td>None</td></tr> <tr><td>1</td><td>0-10 VDC Output Frequency</td></tr> <tr><td>2</td><td>2-10 VDC Output Frequency</td></tr> <tr><td>3</td><td>0-10 VDC Load</td></tr> <tr><td>4</td><td>2-10 VDC Load</td></tr> <tr><td>5</td><td>0-10 VDC Torque</td></tr> <tr><td>6</td><td>2-10 VDC Torque</td></tr> <tr><td>7</td><td>0-10 VDC Power (kW)</td></tr> <tr><td>8</td><td>2-10 VDC Power (kW)</td></tr> <tr><td>9</td><td>Network Controlled</td></tr> <tr><td>10</td><td>Sequencer Controlled</td></tr> </tbody> </table> |                    | 0           | None   | 1           | 0-10 VDC Output Frequency | 2  | 2-10 VDC Output Frequency | 3 | 0-10 VDC Load | 4   | 2-10 VDC Load | 5   | 0-10 VDC Torque | 6 | 2-10 VDC Torque | 7   | 0-10 VDC Power (kW)   | 8 | 2-10 VDC Power (kW) | 9 | Network Controlled | 10 | Sequencer Controlled | <p>2-10 VDC signal can be converted to 4-20 mA with a total circuit impedance of 500 Ω</p> <p>SMV models &lt; 15HP (11kW) require an optional communication module (refer to the network module documentation).<br/>           Value set in individual sequencer segments</p> |
|  |                                  |                    | 0  | None               |             |  |             |                           |    |                           |   |               |     |               |     |                 |   |                 |     |   |   |                     |   |                    |    |                      |   |
| 1  | 0-10 VDC Output Frequency        |                    |  |                    |             |  |             |                           |    |                           |   |               |     |               |     |                 |   |                 |     |   |   |                     |   |                    |    |                      |   |
| 2  | 2-10 VDC Output Frequency        |                    |  |                    |             |  |             |                           |    |                           |   |               |     |               |     |                 |   |                 |     |   |   |                     |   |                    |    |                      |   |
| 3  | 0-10 VDC Load                    |                    |  |                    |             |  |             |                           |    |                           |   |               |     |               |     |                 |   |                 |     |   |   |                     |   |                    |    |                      |   |
| 4  | 2-10 VDC Load                    |                    |  |                    |             |  |             |                           |    |                           |   |               |     |               |     |                 |   |                 |     |   |   |                     |   |                    |    |                      |   |
| 5  | 0-10 VDC Torque                  |                    |  |                    |             |  |             |                           |    |                           |   |               |     |               |     |                 |   |                 |     |   |   |                     |   |                    |    |                      |   |
| 6  | 2-10 VDC Torque                  |                    |  |                    |             |  |             |                           |    |                           |   |               |     |               |     |                 |   |                 |     |   |   |                     |   |                    |    |                      |   |
| 7  | 0-10 VDC Power (kW)              |                    |  |                    |             |  |             |                           |    |                           |   |               |     |               |     |                 |   |                 |     |   |   |                     |   |                    |    |                      |   |
| 8  | 2-10 VDC Power (kW)              |                    |  |                    |             |  |             |                           |    |                           |   |               |     |               |     |                 |   |                 |     |   |   |                     |   |                    |    |                      |   |
| 9  | Network Controlled               |                    |  |                    |             |  |             |                           |    |                           |   |               |     |               |     |                 |   |                 |     |   |   |                     |   |                    |    |                      |   |
| 10   | Sequencer Controlled             |                    |  |                    |             |  |             |                           |    |                           |   |               |     |               |     |                 |   |                 |     |   |   |                     |   |                    |    |                      |   |
| <table border="1"> <thead> <tr> <th>P151</th> <th>Add TB-25 (4-20mA)</th> <th>Add TB-5 (0-10VDC)</th> </tr> </thead> <tbody> <tr> <td>0</td> <td>NO</td> <td>NO</td> </tr> <tr> <td>1</td> <td>NO</td> <td>YES</td> </tr> <tr> <td>2</td> <td>YES</td> <td>NO</td> </tr> <tr> <td>3</td> <td>YES</td> <td>YES</td> </tr> </tbody> </table> |                                  | P151               | Add TB-25 (4-20mA)   | Add TB-5 (0-10VDC) | 0           | NO   | NO          | 1                         | NO | YES                       | 2 | YES           | NO  | 3             | YES | YES             |   |                 |     |   |   |                     |   |                    |    |                      |   |
| P151   | Add TB-25 (4-20mA)               | Add TB-5 (0-10VDC) |  |                    |             |  |             |                           |    |                           |   |               |     |               |     |                 |   |                 |     |   |   |                     |   |                    |    |                      |   |
| 0  | NO                               | NO                 |  |                    |             |  |             |                           |    |                           |   |               |     |               |     |                 |   |                 |     |   |   |                     |   |                    |    |                      |   |
| 1  | NO                               | YES                |  |                    |             |  |             |                           |    |                           |   |               |     |               |     |                 |   |                 |     |   |   |                     |   |                    |    |                      |   |
| 2  | YES                              | NO                 |  |                    |             |  |             |                           |    |                           |   |               |     |               |     |                 |   |                 |     |   |   |                     |   |                    |    |                      |   |
| 3  | YES                              | YES                |  |                    |             |  |             |                           |    |                           |   |               |     |               |     |                 |   |                 |     |   |   |                     |   |                    |    |                      |   |
| P 151  | Add Analog Input to TB-30 Output | 0                  |  |                    |             | <p>This parameter adds the analog input signal(s) to the TB-30 Output signal. EXAMPLE: If a drive is running at 60Hz with P150 set to 1 (0-10VDC Freq) and P152 set to 240.0Hz, the output at TB-30 would be 2.5VDC. If there is a 2.0VDC signal going into TB-5 and P151 is set to 1 (ADD TB-5), the output at TB-30 would become 4.5VDC.</p> |             |                           |    |                           |   |               |     |               |     |                 |   |                 |     |   |   |                     |   |                    |    |                      |   |
| P 152  | TB-30 Scaling: Frequency         | 60.0               | 3.0  | (Hz)               | 2000        | If P150 = 1 or 2, sets the frequency at which output equals 10 VDC   |             |                           |    |                           |   |               |     |               |     |                 |   |                 |     |   |   |                     |   |                    |    |                      |   |
| P 153  | TB-30 Scaling: Load              | 200                | 10   | (%)                | 500         | If P150 = 3 or 4, sets the Load (as a percent of drive current rating) at which output equals 10 VDC.  |             |                           |    |                           |   |               |     |               |     |                 |   |                 |     |   |   |                     |   |                    |    |                      |   |
| P 154  | TB-30 Scaling: Torque            | 100                | 10   | (%)                | 1000        | If P150 = 5 or 6, sets the Torque (as a percent of motor rated torque) at which output equals 10 VDC   |             |                           |    |                           |   |               |     |               |     |                 |   |                 |     |   |   |                     |   |                    |    |                      |   |
| P 155  | TB-30 Scaling: Power (kW)        | 1.0                | 0.1  | (kW)               | 200.0       | If P150 = 7 or 8, sets the power at which output equals 10 VDC   |             |                           |    |                           |   |               |     |               |     |                 |   |                 |     |   |   |                     |   |                    |    |                      |   |

## Commissioning



### 4.5.3 Advanced Setup Parameters

| Code  |  | Possible Settings  |  |            | IMPORTANT   |
|-------|--|--|--|------------|---|
| No.   | Name   | Default  | Selection  |            |   |
| P 156 | Analog Inputs Configuration                    | 0  | 0 TB5: (0-10 VDC); TB25: (4-20mA)<br>1 TB5: (0 - 5 VDC); TB25: (4-20mA)<br>2 TB5: (2 - 10 VDC); TB25: (4-20mA)<br>4 TB5: (0-10 VDC); TB25: (0-20mA)<br>5 TB5: (0 - 5 VDC); TB25: (0-20mA)<br>6 TB5: (2 - 10 VDC); TB25: (0-20mA)   |            |   |
| P 157 | TB5 (0-10V) Analog Input Monitoring Action     | 0  | 0 No Action<br>1 If TB5 < P158 - Trip Fault $F\_FRU$<br>2 If TB5 < P158 - Run Preset #8<br>3 If TB5 < P158 - Run Preset Seg. #16<br>4 If TB5 > P158 - Trip Fault $F\_FRU$<br>5 If TB5 > P158 - Run Preset #8<br>6 If TB5 > P158 - Run Preset Seg. #16                      |            | Selects the reaction to a loss of the 0-10V signal at TB5<br><br>500ms is the minimum time above/below Monitoring Level (P158) before triggering the drive to trip or run at a preset speed.<br><br>For P157 = 3 or 6, the accel/decel time is set in P786.<br>NOTE: P157 has priority over P163 and TB-13 presets/auto references (P121-P124)  |
| P 158 | TB5 (0-10V) Analog Input Monitoring Level (ML) | 0.0  | -10.0  | (VDC) 10.0 | Negative input voltage is not currently supported.  |
| P 159 | 0-10V Analog Input Deadband                    | 0.0  | 0  | (VDC) 10.0 | Not active if [-10 to +10 VDC] option is selected.  |
| P 160 | Speed at Minimum Signal                        | 0.0  | -999.0   | (Hz) 1000  | <p style="text-align: right;">V0111</p>   |
| P 161 | Speed at Maximum Signal                        | 60.0   | -999.0   | (Hz) 1000  |   |
|       |  | <div style="border: 1px solid black; padding: 2px; display: inline-block;"> <b>i</b> NOTE                     </div> <ul style="list-style-type: none"> <li>P160 sets the output frequency at 0% analog input</li> <li>P161 sets the output frequency at 100% analog input</li> <li>P160 or P161 &lt; 0.0 Hz: For scaling purposes only; does not indicate opposite direction!</li> <li>P160 &gt; P161: Drive will react inversely to analog input signal</li> </ul> |  |            |   |
| P 162 | Analog Input Filter                            | 0.01   | 0.00   | (s) 10.00  | <ul style="list-style-type: none"> <li>Adjusts the filter on the analog inputs (TB-5 and TB-25) to reduce the effect of signal noise</li> <li>The P162 delay time will affect the response time of diagnostic parameters (P520-P523).</li> </ul>  |
| P 163 | TB-25 (4-20mA) Analog Input Monitoring Action  | 0  | 0 No Action<br>1 If TB25 < P164 - Trip Fault $F\_FoL$<br>2 If TB25 < P164 - Run Preset #7<br>3 If TB25 < P164 - Run Preset Seg. #15<br>4 If TB25 $\geq$ P164 - Trip Fault $F\_FoL$<br>5 If TB25 $\geq$ P164 - Run Preset #7<br>6 If TB25 $\geq$ P164 - Run Preset Seg. #15 |            | <ul style="list-style-type: none"> <li>Selects the reaction to a loss of the 4-20 mA signal at TB-25.</li> <li>Signal is considered lost if it falls below the value set in P164</li> <li>Digital outputs can also indicate a loss of 4-20 mA signal; see P140, P142</li> <li>For P163 = 3 or 6, the accel/decel time is set in P781.</li> </ul> NOTE: P163 has priority over TB-13 presets/auto references (P121-P124) |



## Commissioning

| Code                 |  | Possible Settings |           |  |       | IMPORTANT  |
|----------------------|--|-------------------|-----------|--|-------|--|
| No.                  | Name   | Default           | Selection |  |       |  |
| P 154                | TB-25 (4-20mA) Analog Input Monitoring Level | 2.0               | 0.0       | (mA)   | 20.0  |  |
| P 155                | Base Voltage                                 |                   | 15        | (V)  | 1000  | Valid for V/Hz mode only.<br>Set voltage for bus compensation in V/Hz mode   |
| P 156                | Carrier Frequency                            | See Notes         | 0         | 4 kHz  |       | <ul style="list-style-type: none"> <li>As carrier frequency is increased, motor noise is decreased</li> <li>Observe derating in section 2.3</li> <li>Automatic shift to 4 kHz at 120% load</li> <li>NEMA 4X (IP65) Models: Default = 0 (4kHz)</li> <li>NEMA 1 (IP31) Models: Default = 1 (6kHz)</li> </ul>   |
| P 157 <sup>(1)</sup> | Base Frequency                               | 60.0              | 10.0      | (Hz)   | 1500  | <p>V0112</p>   |
| P 168                | Fixed Boost                                  |                   | 0.0       | (%)  | 40.0  |  |
|                      |  |                   |           | <b>NOTE</b> <ul style="list-style-type: none"> <li>P167 = rated motor frequency for standard applications</li> <li>P165, P168 = default setting depends on drive rating</li> </ul> |       |  |
| P 169                | Accel Boost                                  | 0.0               | 0.0       | (%)  | 20.0  | Accel Boost is only active during acceleration   |
| P 170                | Slip Compensation                            | 0.0               | 0.0       | (%)  | 40.0  | Increase P170 until the motor speed no longer changes between no load and full load conditions.  |
| P 171 <sup>(1)</sup> | Current Limit                                | Max I             | 30        | (%)  | Max I | <ul style="list-style-type: none"> <li>When the limit is reached, the drive displays CL (Current Limit), and either the acceleration time increases or the output frequency decreases.</li> <li>Digital outputs can also indicate when the limit is reached; see P140, P142.</li> <li>Refer to section 2.3 for the maximum output current Max I (%)</li> </ul> |
| P 172                | Current Limit Reduction                      | 0                 | 0         | Current Limit Reduction Active - Normal response   |       | In field weakening, the Current Limit is inversely proportional to the speed.  |
|                      |  |                   | 1         | Current Limit Reduction Active - Fast response   |       |  |
|                      |  |                   | 2         | Current Limit Reduction Disabled - Normal response   |       |  |
|                      |  |                   | 3         | Current Limit Reduction Disabled - Fast response   |       |  |
| P 173                | Decel Override Time                          | 2.0               | 0.0       | (s)  | 60.0  | Maximum time before drive trips into HF fault.   |
| P 174                | DC Brake Voltage                             | 0.0               | 0.0       | (%)  | 50.0  | Setting is a percent of the nominal DC bus voltage.  |

(1) Any changes to this parameter will not take effect until the drive is stopped.

## Commissioning



| Code      | Name                                   | Possible Settings |  | IMPORTANT  |
|-----------|--|-------------------|--|--|
|           |  | Default           | Selection  |  |
| P 175     | DC Brake Time                          | 0.0               | 0.0 (s) 999.9  |  |
|           |  |                   | NOTE: CONFIRM MOTOR SUITABILITY FOR USE WITH DC BRAKING<br>DC Brake voltage (P174) is applied for the time specified by P175 with the following exceptions: <ul style="list-style-type: none"> <li>• If P111=1, 3 and P175=999.9 the brake voltage will be applied continuously until a run or fault condition occurs.</li> <li>• If P110=2, 4...6 and P175=999.9, brake voltage will be applied for 15s</li> <li>• If P121...P124=18 and the corresponding TB-13 input is CLOSED, brake voltage will be applied until the TB-13 input is OPENED or a fault condition occurs.</li> </ul> |  |
| P 176     | Keypad Setpoint Single Press Increment | 0.1               | 0.1 100.0  | Used for run screen setpoint editing only. If P176 > 0.1 then scrolling of keypad setpoint is enabled.   |
| P 177 (2) | Speed Units                            | 0                 | 0 Hz<br>1 RPM<br>2 %<br>3 /UNITS<br>4 NONE   | Select the UNITS LED that will be illuminated when the drive is running in speed control mode. For this parameter to be used, P178 must be set to a value other than 0. If P178 is set to 0, the Hz LED will be illuminated regardless of the value set in P177.   |
| P 178     | Display Frequency Multiplier           | 0.00              | 0.00 650.00  | <ul style="list-style-type: none"> <li>• Allows frequency display to be scaled</li> <li>• P178 = 0.00: Scaling disabled</li> <li>• P178 &gt; 0.00: Display = Actual Frequency X P178</li> </ul>  |
|           |  |                   | EXAMPLE<br>If P178 = 29.17 and actual frequency = 60 Hz, then Drive displays 1750 (rpm)  |  |
| P 179     | Run Screen Display                     | 0                 | 0 (Parameter Number) 599   | <ul style="list-style-type: none"> <li>• 0 = Normal Run Screen, this display depends on mode of operation. Refer to section 4.2.</li> <li>• Other selections choose a diagnostic parameter to display (P501...P599).</li> <li>• Parameters P560 - P564 are selectable if the sequencer is enabled (P700 is not 0). P560-P564 are not visible until P700 is enabled.</li> </ul> |
| P 180     | Oscillation Damping Control            | 0                 | 0 80   | 0 = Damping disabled<br>Compensation for resonances within drive   |
| P 181     | Skip frequency 1                       | 0.0               | 0.0 (Hz) 500   | <ul style="list-style-type: none"> <li>• Drive will not run in the defined skip range; used to skip over frequencies that cause mechanical vibration</li> <li>• P181 and P182 define the start of the skip ranges</li> <li>• P184 &gt; 0 defines the bandwidth of both ranges.</li> </ul>  |
| P 182     | Skip frequency 2                       | 0.0               | 0.0 (Hz) 500   |  |
| P 184     | Skip frequency bandwidth               | 0.0               | 0.0 (Hz) 10.0  |  |
|           |  |                   | NOTE<br>Bandwidth (Hz) = $f_1$ (Hz) + P184 (Hz) $f_1$ = P181 or P182<br>EXAMPLE: P181 = 18 Hz and P184 = 4 Hz; skip range is from 18 to 22 Hz  |  |
| P 185     | Voltage Midpoint V/Hz characteristic   | 0                 | 0.0 (V) P165   | Valid only when P300 = 0 or 2.<br>Use with P187 to define midpoint on V/Hz curve.  |
| P 187 (2) | Frequency Midpoint V/Hz characteristic | 0.0               | 0.0 (Hz) P167  | Valid only when P300 = 0 or 2.<br>Use with P185 to define midpoint on V/Hz curve.  |
| P 189 (2) | Integrated Dynamic Brake               |                   | 0 Disabled<br>1 Enabled  |  |

(2) Parameter applicable to SMV models 15HP (11kW) and higher.

(3) Parameter applicable to SMV models 40HP (30kW) and higher.



## Commissioning

| Code  |  | Possible Settings |  | IMPORTANT   |
|-------|--|-------------------|--|---|
| No.   | Name                                       | Default           | Selection  |   |
| P 190 | Motor Braking                              |                   | 0 Disabled<br>1 Braking with BUS threshold<br>2 Braking always on with deceleration<br>3 Braking with bus regulator<br>4 Special   | Flux brake OFF.<br>When drive is in deceleration and $V_{bus} > V_{bus\_max\_trip} (114\% \text{ of the rated } V_{bus})$ , the flux brake will be turned ON.<br>As long as drive is in deceleration, the flux brake will be ON.<br>When drive is in deceleration and $V_{bus} > V_{bus\_max\_trip} (114\% \text{ of the rated } V_{bus})$ , the motor speed will be increased to reduce the bus voltage. Determined by the value in P191, the speed increment = slip speed * P191(%) / 37.<br>(Consult factory before using) |
|       |  |                   | <b>WARNING</b><br>Flux braking can cause heat in the motor. To avoid damage to the motor, use a PTC to protect the motor. If the flux brake is used too frequently, the drive will trip fault "F_PF".  |   |
| P 191 | Motor Brake Level                          | 0                 | 0 (%) 75<br>(flux braking disabled)  | Active when P190 > 0 and drive is in deceleration mode. Use to reduce deceleration time on high inertia loads.<br><b>NOTE:</b> Over usage of P190 can cause frequent 'overload' trips "F_PF"<br>Not active for P300 = 5 (Torque mode)   |
| P 192 | Motor Braking Deceleration Reduction Level | 0.0               | 0 P167 (base freq)<br>Raising the value of P191 reduces the drive deceleration rate during flux braking.   | Active when P190 > 0 and P192 > 0.0. Drive is in deceleration mode. Use to reduce deceleration time on high inertia loads.<br><b>NOTE:</b> Usage of P192 can cause the drive to decelerate faster than settings in P105/P127.<br>Not active for P300 = 5 (Torque mode)  |
| P 194 | Password                                   | 0                 | 0000 9999  | <ul style="list-style-type: none"> <li>Must enter password to access parameters</li> <li>P194 = 0000: Disables password</li> </ul>  |
| P 197 | Clear Fault History                        | 0                 | 0 No Action<br>1 Clear Fault History   |   |
| P 199 | Program Selection                          |                   | 0 Operate from User settings<br>1 Operate from OEM settings<br>2 Reset to OEM default settings<br>3 Reset to 60 Hz default settings<br>4 Reset to 50 Hz default settings<br>5 Translate  | Refer to Notes 1, 2 and 3<br>Refer to Note 1<br><ul style="list-style-type: none"> <li>Refer to Note 4</li> <li>Parameters are reset to the defaults listed in this manual.</li> <li>For P199=4, the following exceptions apply:               <ul style="list-style-type: none"> <li>- P103, P152, P161, P167 = 50.0 Hz</li> <li>- P165 = 400V (400/480V drives only)</li> <li>- P304 = 50 Hz</li> <li>- P305 = 1450 RPM</li> <li>- P107 = 0 (480 V drives only)</li> </ul> </li> </ul> Refer to Note 5                      |
|       |  |                   | <b>WARNING!</b><br>Modification of P199 can affect drive functionality! STOP and EXTERNAL FAULT circuitry may be disabled! Check P100 and P121...P124  |   |
|       |  |                   | <b>NOTE 1</b><br>If the EPM does not contain valid OEM settings, a flashing CF will be displayed when P199 is set to 1 or 2.<br><b>NOTE 2</b><br>When P199 is set to 1, the drive operates from the OEM settings stored in the EPM Module and no other parameters can be changed (GE will be displayed if attempted).<br><b>NOTE 3</b><br>Auto Calibration is not possible when operating from OEM Settings.<br><b>NOTES 4 and 5 - on next page.</b> |   |

## Commissioning



| Code  |                   | Possible Settings |  | IMPORTANT |
|-------|-------------------|-------------------|--|-----------|
| No.   | Name              | Default           | Selection  |           |
| P 199 | Program Selection |                   | <p><b>NOTE 4</b><br/>Resetting to 50 and 60 Hz default settings will set the Assertion Level (P120) to "2" (High). P120 may need to be reset for the digital input devices being used. An F<sub>AL</sub> fault may occur if P120 and the Assertion switch are not set identically.</p> <p><b>NOTE 5</b><br/>If an EPM that contains data from a previous compatible software version is installed:</p> <ul style="list-style-type: none"> <li>The drive will operate according to the previous data, but parameters cannot be changed (⌂E will be displayed if attempted)</li> <li>To update the EPM to the current software version, set P199 = 5. The parameters can now be changed but the EPM is incompatible with previous software revisions.</li> </ul> |           |

### 4.5.4 PID Parameters

| Code                |                            | Possible Settings |   | IMPORTANT  |
|---------------------|----------------------------|-------------------|---|--|
| No.                 | Name                       | Default           | Selection   |  |
| P200                | PID Mode                   | 0                 | 0 Disabled<br>1 Normal-acting<br>2 Reverse-acting<br>3 Normal-acting, Bi-directional<br>4 Reverse-acting, Bi-directional  | <ul style="list-style-type: none"> <li>Normal-acting: As feedback increases, motor speed decreases</li> <li>Reverse-acting: As feedback increases, motor speed increases</li> <li>PID mode is disabled in Vector Torque mode (P300 = 5)</li> <li>Selections 3, 4: If P112=1, PID controller output sets the speed, (range -max freq to +max freq)</li> </ul> |
|                     |                            |                   | <p><b>NOTE</b><br/>To activate PID mode, one of the TB-13 inputs (P121...P124) must be used to select the Auto Reference that matches the desired PID setpoint reference. If the selected PID setpoint reference uses the same analog signal as the PID feedback (P201), an F<sub>IL</sub> fault will occur.<br/>Example: The desired PID setpoint reference is the keypad (▲ and ▼). Set TB-13x = 6 (Auto Reference: Keypad):</p> <ul style="list-style-type: none"> <li>TB-13x = closed: PID mode is active</li> <li>TB-13x = open: PID mode is disabled and the drive speed will be controlled by the reference selected in P101.</li> </ul> |  |
| P201                | PID Feedback Source        | 0                 | 0 4-20 mA (TB-25)<br>1 0-10 VDC (TB-5)<br>2 Drive Load (P507)<br>3 Feedback from Network  | Must be set to match the PID feedback signal   |
| P202                | PID Decimal Point          | 1                 | 0 PID Display = XXXX<br>1 PID Display = XXX.X<br>2 PID Display = XX.XX<br>3 PID Display = X.XXX<br>4 PID Display = .XXXX  | Applies to P204, P205, P214, P215, P231...P233, P242, P522, P523   |
| P203 <sup>(2)</sup> | PID Units                  | 0                 | 0 %<br>1 /UNITS<br>2 AMPS<br>3 NONE   | Select the UNITS LED that will be illuminated when the drive is running in PID control mode  |
| P204                | Feedback at Minimum Signal | 0.0               | -99.9                      3100.0   | Set to match the range of the feedback signal being used   |
| P205                | Feedback at Maximum Signal | 100.0             | -99.9                      3100.0   | Example: Feedback signal is 0 - 300 PSI; P204 = 0.0, P205 = 300.0  |

(2) Parameter applicable to SMV models 15HP (11kW) and higher.



## Commissioning

| Code No. | Name                                   | Possible Settings |  |      |           | IMPORTANT   |
|----------|--|-------------------|--|------|-----------|---|
|          |  | Default           | Selection  |      |           |   |
| P207     | Proportional Gain                      | 5.0               | 0.0  | (%)  | 1000.0    | Used to tune the PID loop: <ul style="list-style-type: none"> <li>• Increase P207 until system becomes unstable, then decrease P207 by 10-15%</li> <li>• Next, increase P208 until feedback matches setpoint</li> <li>• If required, increase P209 to compensate for sudden changes in feedback</li> </ul>  |
| P208     | Integral Gain                          | 0.0               | 0.0  | (s)  | 20.0      |   |
| P209     | Derivative Gain                        | 0.0               | 0.0  | (s)  | 20.0      |   |
|          |  |                   | NOTE <ul style="list-style-type: none"> <li>• Derivative Gain is very sensitive to noise on the feedback signal. Use with care. Derivative Gain is not normally required in pump and fan applications</li> </ul> |      |           |   |
| P210     | PID Setpoint Ramp                      | 20.0              | 0.0  | (s)  | 100.0     | <ul style="list-style-type: none"> <li>• time of setpoint change from P204 to P205 or vice versa.</li> <li>• Used to smooth the transition from one PID setpoint to another, such as when using the Preset PID Setpoints (P231...P233)</li> </ul>   |
| P214     | Minimum Alarm                          | 0.0               | P204   |      | P205      | Use with P140, P142 = 18...23   |
| P215     | Maximum Alarm                          | 0.0               | P204   |      | P205      |   |
| P231     | Preset PID Setpoint #1                 | 0.0               | P204   |      | P205      | TB-13A activated; P121 = 3 and P200 = 1 or 2  |
| P232     | Preset PID Setpoint #2                 | 0.0               | P204   |      | P205      | TB-13B activated; P122 = 3 and P200 = 1 or 2  |
| P233     | Preset PID Setpoint #3                 | 0.0               | P204   |      | P205      | TB-13C activated; P123 = 3 and P200 = 1 or 2  |
| P234     | Preset PID Setpoint #4                 | 0.0               | P204   |      | P205      | TB-13D activated; P124 = 3 and P200 = 1 or 2  |
| P240     | Sleep Threshold                        | 0.0               | 0.0  | (Hz) | 500.0     | <ul style="list-style-type: none"> <li>• If drive speed &lt; P240 for longer than P241, output frequency = 0.0 Hz; drive display = SLP</li> <li>• P240 = 0.0: Sleep mode is disabled.</li> <li>• P200 = 0...2: Drive will start again when speed command is above P240</li> <li>• P242 &gt; 0.0: Drive will restart when the PID feedback differs from the setpoint by more than the value of P242 or when the PID loop requires a speed above P240.</li> </ul> |
| P241     | Sleep Delay                            | 30.0              | 0.0  | (s)  | 300.0     |   |
| P242     | Sleep Bandwidth                        | 0.0               | 0.0  |      | $B_{max}$ |   |
|          |  |                   | Where: $B_{max} = 1/(P205 - P204)$   |      |           |   |
| P243     | Feedback Sleep Entry Threshold         | 0.0               | P204   |      | P205      | Active only when P244 = 1 or 2  |
| P244     | Sleep Entry Mode                       | 0                 | 0 Enter SLEEP if Drive Speed < P240<br>1 Enter SLEEP if Feedback > P243<br>2 Enter SLEEP if Feedback < P243  |      |           | For time longer than P241<br>For time longer than P241 or same as Sel 0<br>For time longer than P241 or same as Sel 0   |
| P245     | Sleep Entry Stop Type                  | 0                 | 0 Coast to Stop<br>1 Ramp to Stop<br>2 Stop with P111 settings   |      |           |   |
| P246     | Feedback Recovery from Sleep Threshold | 0.0               | P204   |      | P205      | Active only when P247 = 1 or 2  |
| P247     | Sleep Recovery Mode                    | 0                 | 0 Recovery if Speed Setpoint > P240 or if PID feedback differs from setpoint by more than P242<br>1 Recovery only if Feedback < P246<br>2 Recovery only if Feedback > P246                                       |      |           |   |

(2) Parameter applicable to SMV models 15HP (11kW) and higher.

## Commissioning



| Code |                                      | Possible Settings |  |  | IMPORTANT   |
|------|--------------------------------------|-------------------|--|--|---|
| No.  | Name                                 | Default           | Selection  |  |   |
| P250 | Auto Rinse in Sleep Mode             | 0                 | 0 Disabled<br>1 Enabled  |  | Activated in sleep mode only. Sleep Recovery cancels Auto Rinse |
| P251 | Time Delay between Auto Rinses       | 30.0              | 0.0 (min) 6553.5   |  | Time delay reset by re/entering sleep mode                      |
| P252 | Auto Rinse Speed                     | 0.0               | -500.0 (Hz) 500.0  |  | If P112 = 1, negative sign = reverse direction                  |
| P253 | Auto Rinse Time                      | 0.0               | 0.0 (sec) 6553.5   |  | Does not include time to decel back to speed                    |
|      |                                      |                   | Auto Pump Rinse Setup:<br>P250=1 (Enabled)<br>P251=# minutes between each PumpRinse<br>P252=Hz speed of Pump Rinse<br>P253=# seconds Pump Rinse duration |  |   |
| P280 | Current Level: Flying Restart Type 2 | 70.0              | 0.0 (%) P171   |  | Maximum current during Type 2 flying restart operation          |
| P281 | Decel Time: Flying Restart Type 2    | 3.0               | 0.0 (sec) 3600.0   |  | Deceleration rate used during Type 2 flying restart operation   |

### 4.5.5 Vector Parameters

| Code                |                     | Possible Settings |   |  | IMPORTANT   |
|---------------------|---------------------|-------------------|---|--|---|
| No.                 | Name                | Default           | Selection   |  |   |
| P300 <sup>(1)</sup> | Drive Mode          | 0                 | 0 Constant V/Hz<br>1 Variable V/Hz<br>2 Enhanced Constant V/Hz<br>3 Enhanced Variable V/Hz<br>4 Vector Speed<br>5 Vector Torque   |  | Constant torque V/Hz control for general applications<br>Variable torque V/Hz control for centrifugal pump and fan applications<br>For single or multiple motor applications that require better performance than settings 0 or 1, but cannot use Vector mode, due to: <ul style="list-style-type: none"> <li>• Missing required motor data</li> <li>• Vector mode causing unstable motor operation</li> </ul> For single-motor applications requiring higher starting torque and speed regulation<br>For single-motor applications requiring torque control independent of speed |
|                     |                     |                   | <b>NOTE</b><br>To configure the drive for either Vector mode or Enhanced V/Hz mode: <ul style="list-style-type: none"> <li>• P300 = 4, 5:                             <ul style="list-style-type: none"> <li>- Set P302...P306 according to motor nameplate</li> <li>- Set P399 = 1 or 2 (if option 1 failed or in case of non-standard motor)</li> <li>- Make sure motor is cold (20° - 25° C) and apply a Start command</li> <li>- Display will indicate <b>CAL</b> for about 40 seconds</li> <li>- Once the calibration is complete, the display will indicate <b>5toP</b>; apply another Start command to actually start the motor</li> <li>- If an attempt is made to start the drive in Vector or Enhanced V/Hz mode before performing the Motor Calibration, the drive will display <b>F_n Id</b> and will not operate</li> </ul> </li> <li>• P300 = 2, 3: Same as above but only need to set P302...P304</li> </ul> |  |   |
| P302 <sup>(1)</sup> | Motor Rated Voltage | 0                 | (V) 600   |  | • Default setting = drive rating  |
| P303 <sup>(1)</sup> | Motor Rated Current | 0,1               | (A) 500,0   |  | • Set to motor nameplate data   |

(1) Any changes to this parameter will not take effect until the drive is stopped.





## Commissioning

| Code No. | Name                              | Possible Settings |  |              |       | IMPORTANT  |
|----------|-----------------------------------|-------------------|--|--------------|-------|--|
|          |                                   | Default           | Selection  |              |       |  |
| P304 (1) | Motor Rated Frequency             | 60                | 0  | (Hz)         | 1000  | Set to motor nameplate data  |
| P305 (1) | Motor Rated Speed                 | 1750              | 300  | (RPM)        | 65000 |  |
| P306 (1) | Motor Cosine Phi                  | 0.80              | 0.40   |              | 0.99  |  |
|          |                                   |                   | NOTE If motor cosine phi is not known, use one of the following formulas:<br>$\cos \phi = \text{motor Watts} / (\text{motor efficiency} \times P302 \times P303 \times 1.732)$<br>$\cos \phi = \cos [ \sin^{-1} (\text{magnetizing current} / \text{motor current}) ]$   |              |       |  |
| P310 (2) | Motor Stator Resistance           |                   | 0.00   | ( $\Omega$ ) | 64.00 | <ul style="list-style-type: none"> <li>P310, 311 default setting depends on drive rating</li> <li>Will be automatically programmed by P399</li> <li>Changing these settings can adversely affect performance. Contact factory technical support prior to changing</li> </ul>   |
| P311 (2) | Motor Stator Inductance           |                   | 0.0  | (mH)         | 2000  |  |
| P315     | Dead Time Compensation Factor     | 0.0               | -50.0  | (%)          | +50.0 | <ul style="list-style-type: none"> <li>Adjust dead time correction from internal default</li> <li>Takes effect when P399 = 3.</li> </ul>   |
| P330     | Torque Limit                      | 100               | 0  | (%)          | 400   | When P300 = 5, sets the maximum output torque.   |
| P331     | Preset Torque Setpoint #1         | 100               | 0  | (%)          | 400   | TB-13A activated; P121 = 3 and P300 = 5  |
| P332     | Preset Torque Setpoint #2         | 100               | 0  | (%)          | 400   | TB-13B activated; P122 = 3 and P300 = 5  |
| P333     | Preset Torque Setpoint #3         | 100               | 0  | (%)          | 400   | TB-13C activated; P123 = 3 and P300 = 5  |
| P334 (2) | Preset Torque Setpoint #4         | 100               | 0  | (%)          | 400   | TB-13D activated; P124 = 3 and P300 = 5  |
| P340 (1) | Current Loop P Gain               | 0.25              | 0.00   |              | 16.0  | Changing these settings can adversely affect performance. Contact factory technical support prior to changing.   |
| P341 (1) | Current Loop I Gain               | 65                | 12   | (ms)         | 9990  |  |
| P342 (1) | Speed Loop Adjust                 | 0.0               | 0.0  | (%)          | 20.0  |  |
| P343     | Slip Compensation Response Filter | 99                | 90   | (ms)         | 9999  | Low pass filter time constant for varying the slip compensation response to changes in the motor current.  |
| P399     | Motor Auto-calibration            | 0                 | 0  |              |       | <ul style="list-style-type: none"> <li>If P300 = 4 or 5, motor calibration must be performed if P399 is not set to 3 (bypass calibration).</li> <li>If P300=2 or 3, motor calibration is recommended.</li> <li>Use option 2 if option 1 failed or in case of non-standard motors</li> <li>An alternating <i>CAL</i> / <i>Err</i> will occur if:               <ul style="list-style-type: none"> <li>- attempt motor calibration with P300 = 0 or 1</li> <li>- motor calibration is attempted before programming motor data</li> </ul> </li> </ul> |
|          |                                   |                   | NOTE: To run the Auto Calibration: <ul style="list-style-type: none"> <li>- Set P302...P306 according to motor nameplate</li> <li>- Set P399 = 1 or 2 (if option 1 failed or in case of non-standard motor)</li> <li>- Make sure motor is cold (20° - 25° C)</li> <li>- Apply a Start command</li> <li>- Display will indicate CAL for about 40 seconds</li> <li>- Once the calibration is complete, the display will indicate Stop; apply another Start command to actually start the motor</li> <li>- Parameter P399 will now be set to 4 or 5.</li> </ul> |              |       |  |

- (1) Any changes to this parameter will not take effect until the drive is stopped.  
 (2) Parameter applicable to SMV models 15HP (11kW) and higher.

## Commissioning



### 4.5.6 Network Parameters

| Code          |                       | Possible Settings          |   | IMPORTANT  |
|---------------|-----------------------|----------------------------|---|--|
| No.           | Name                  | Default                    | Selection   |  |
| P400          | Network Protocol      |                            | 0 Not Active<br>1 Remote Keypad<br>2 Modbus RTU<br>3 CANopen<br>4 DeviceNet<br>5 Ethernet<br>6 Profibus<br>7 Lecom-B<br>8 I/O Module  | This parameter setting is based upon the network or I/O module that is installed.  |
| P401          | Module Type Installed | 0                          | 0 No Module Installed<br>1 Basic I/O (0x0100, 1.0.0)<br>2 RS485/Rem. Keypad (0x0200, 2.0.0)<br>3 CANopen (0x0300, 3.0.0)<br>11 PROFIBUS (0x1100, 11.0.0)<br>12 Ethernet (0x1200, 12.0.0)                      | Module type format: 0xAABC; Drive Display: AA.B.C<br>AA = Module Type<br>B = Major revision<br>C = minor revision  |
| P402          | Module Status         | 0                          | 0 Not Initialized<br>1 Initialization: Module to EPM<br>2 Initialization: EPM to Module<br>3 Online<br>4 Failed Initialization Error<br>5 Time-out Error<br>6 Initialization Failed<br>7 Initialization Error | Module type mismatch P401<br>Protocol selection mismatch P400  |
| P403          | Module Reset          | 0                          | 0 No Action<br>1 Reset parameters to default values   | Returns module parameters 401...499 to the default values shown in the manual  |
| P404          | Module Timeout Action | 3                          | 0 No Fault<br>1 STOP (see P111)<br>2 Quick Stop<br>3 Fault (F_ntF)  | Action to be taken in the event of a Module/ Drive Time-out.<br>Time is fixed at 200ms<br>STOP is by the method selected in P111.  |
| P405          | Current Network Fault |                            | 0 No Fault<br>1 F.nF1<br>2 F.nF2<br>3 F.nF3<br>4 F.nF4<br>5 F.nF5<br>6 F.nF6<br>7 F.nF7   | NetIdle Mode<br>Loss of Ethernet I/O connection<br>Network Fault<br>Explicit Message Timeout<br>Overall Network Timeout<br>Overall Explicit Timeout<br>Overall I/O Message Timeout |
| P406          | Proprietary           |                            |   | Manufacturer specific  |
| P407 ... P499 |                       | Module Specific Parameters |   | Refer to the Communications Reference Guide specific to the network or I/O module installed.   |



# Commissioning

## 4.5.7 Diagnostic Parameters

| Code | Name                           | Display Range (READ ONLY) | IMPORTANT   |
|------|--------------------------------|---------------------------|---|
| P500 | Fault History                  |                           | <ul style="list-style-type: none"> <li>Displays the last 8 faults</li> <li>Format: n.xxx where: n = 1..8, 1 is the newest fault; xxx = fault message (w/o the F.)</li> <li>Refer to section 5.3</li> </ul>  |
| P501 | Software Version               |                           | Format: x.yz  |
| P502 | Drive ID                       |                           | A flashing display indicates that the Drive ID stored in the EPM does not match the drive model it is plugged into.   |
| P503 | Internal Code                  |                           | Alternating Display: xxx;-yy  |
| P505 | DC Bus Voltage                 | 0 1500 (VDC)              |   |
| P506 | Motor Voltage                  | 0 1000 (VAC)              |   |
| P507 | Load                           | 0 255 (%)                 | Motor load as % of drive's output current rating. Refer to section 2.3.   |
| P508 | Motor Current                  | 0.0 1000 (A)              | Actual motor current  |
| P509 | Torque                         | 0 500 (%)                 | Torque as % of motor rated torque (vector mode only)  |
| P510 | Output Power kW                | 0.00 650.0 (kW)           |   |
| P511 | Total kWh                      | 0.0 9999999 (kWh)         | Alternating display: xxx;-yyyy when value exceeds 9999  |
| P512 | Heatsink Temp                  | 0 150 (°C)                | Heatsink temperature  |
| P520 | 0-10 VDC Input                 | 0.0 10.0 (VDC)            | Actual value of signal at TB-5 (See P162)   |
| P521 | 4-20 mA Input                  | 0.0 20.0 (mA)             | Actual value of signal at TB-25 (See P162)  |
| P522 | TB-5 Feedback                  | P204 P205                 | TB-5 signal value scaled to PID feedback units (See P162)   |
| P523 | TB-25 Feedback                 | P204 P205                 | TB-25 signal value scaled to PID feedback units (See P162)  |
| P524 | Network Feedback               | P204 P205                 | Network signal value scaled to PID feedback units   |
| P525 | Analog Output                  | 0 10.0 (VDC)              | Refer to P150...P155  |
| P527 | Actual Output Frequency        | 0 500.0 (Hz)              |   |
| P528 | Network Speed Command          | 0 500.0 (Hz)              | Command speed if (Auto: Network) is selected as the speed source  |
| P530 | Terminal and Protection Status |                           | Indicates terminal status using segments of the LED display. (Refer to section 4.5.7.1)   |
| P531 | Keypad Status                  |                           | Indicates keypad button status using segments of the LED display. (Refer to section 4.5.7.2)  |
| P540 | Total Run Time                 | 0 9999999 (h)             | Alternating display: xxx;-yyyy when value exceeds 9999  |
| P541 | Total Power On Time            | 0 9999999 (h)             |   |
| P541 | Fault History                  | 1 8                       | <ul style="list-style-type: none"> <li>Displays the last 8 faults</li> <li>Format: n.xxx where: n = 1..8, 1 is the newest fault; xxx = fault message (w/o the F.)</li> <li>Refer to section 5.3</li> </ul>  |
| P551 | Fault History Time             | 0 999999 (h)              | <ul style="list-style-type: none"> <li>The "hhhh" screen is displayed after hours exceed 999.</li> <li>Display: "n.hh" "hhhh" "mm.ss" = fault #, hours, seconds</li> </ul>  |
| P552 | Fault History Counter          | 0 255                     | <ul style="list-style-type: none"> <li>Number of sequential occurrences of a fault</li> <li>For example: 3 external faults occur over a period of time with no other errors occurring. Then P552 will indicate 3. P550 will indicate the error EF and P551 will indicate the time of the first fault occurrence.</li> </ul> |

## Commissioning



| Code |   | Display Range (READ ONLY)   |                               | IMPORTANT                                     |
|------|---|---|-------------------------------|---|
| No.  | Name  |   |                               |   |
| P560 | Sequencer: Currently Active Segment           | 0   | 17                            |   |
| P561 | Sequencer: Time since Start of Active Segment | 0,0<br>0  | (P708) 6553.5<br>(P708) 65535 | Unit depends on P708 (0.1sec, sec or minutes) |
| P562 | Sequencer: Time Remaining in Active Segment   | 0,0<br>0  | (P708) 6553.5<br>(P708) 65535 | Unit depends on P708 (0.1sec, sec or minutes) |
| P563 | Sequencer: Number of cycles since start       | 0   | 65535                         |   |
| P564 | Sequencer: Number of cycles remaining         | 0   | 65535                         |   |
|      |   | NOTE: Parameters P560-P564 are visible only when P700 > 0 (i.e. the sequencer is enabled) |                               |   |

### 4.5.7.1 Terminal & Protection Status Display

Parameter P530 allows monitoring of the control terminal points and common drive conditions:

An illuminated LED segment indicates:

- the protective circuit is active (LED 1)
- the Logic Assertion Switch is set to High (+)
- input terminal is asserted (LED 2)
- output terminal is energized (LED 4)
- the Charge Relay is not a terminal, this segment will be illuminated when the Charge Relay is energized (LED 4).

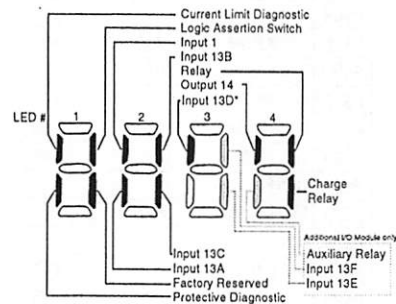

### 4.5.7.2 Keypad Status Display

Parameter P531 allows monitoring of the keypad pushbuttons:

An illuminated LED segment indicates when the button is depressed.

LED 1 and LED 2 are used to indicate pushbutton presses on a remote keypad that is attached to the drive. LED 3 and LED 4 indicate button presses on the local drive keypad.

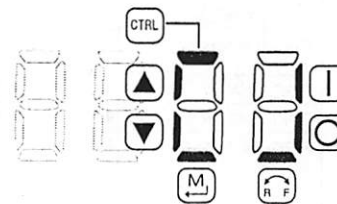





## Commissioning

### 4.5.8 Onboard Communications Parameters 15-60HP (11-45kW)

The P6xx Onboard Communication parameters are applicable to the 15HP (11kW) and higher models only.

| Code No. | Name                         | Possible Settings   |  | IMPORTANT  |
|----------|------------------------------|---|--|--|
|          |                              | Default   | Selection  |  |
| P600     | Network Enable               | 0   | 0 Disabled<br>1 Remote Keypad<br>2 Modbus<br>7 Lecom   | This parameter enables the onboard network communications.   |
|          |                              |    | NOTE: Onboard Communications will be disabled if:<br>- P600 = 0, or<br>- P600 = 1 and P400 = 1, or<br>- P600 = 2 and P400 = 2, 3, 4, 5, 6 or 7<br>- P600 = 7 and P400 = 2, 3, 4, 5, 6 or 7 | If the onboard communications are disabled, the user will not have access to any of the other P6xx parameters. |
| P610     | Network Address              | 1   | 1 - 247  | Modbus   |
|          |                              | 1   | 1 - 99   | Lecom  |
| P611     | Network Baud Rate            | 2   | 0 2400 bps    2 9600 bps<br>1 4800 bps    3 19200 bps  | Modbus   |
|          |                              | 0   | 0 9600 bps<br>1 4800 bps<br>2 2400 bps<br>3 1200 bps<br>4 19200 bps  | Lecom  |
| P612     | Network Data Format          | 0   | 0 8, N, 2<br>1 8, N, 1<br>2 8, E, 1<br>3 8, O, 1   | Modbus Only  |
| P620     | Network Control Level        | 0   | 0 Monitor Only<br>1 Parameter Programming<br>2 Programming and Setpoint Control<br>3 Full Control  | Lecom Only   |
| P624     | Network Powerup Start Status | 0   | 0 Quick Stop<br>1 Controller Inhibit   | Lecom Only   |
| P625     | Network Timeout              | 10.0  | 0.0 - 300.0 seconds  | Modbus   |
|          |                              | 50  | 0 - 65000 milliseconds   | Lecom  |
| P626     | Network Timeout Action       | 4   | 0 No action<br>1 Stop (P111)<br>2 Quick Stop<br>3 Controller Inhibit<br>4 Trip Fault, F.nF1  | Modbus   |
|          |                              | 0   | 0 No action<br>1 Controller Inhibit<br>2 Quick Stop<br>3 Trip Fault, F.nF1   | Lecom  |
| P627     | Network Messages Received    |  | Read-Only: 0 - 9999<br>NOTE: When the number of messages exceeds 9999, the counter resets and resumes counting from 0.   | Valid network messages received  |



## 4.5.9 Sequencer Parameters

The P700 Sequencer parameters are listed herein. Refer to section 4.5.7 for P56x Sequencer Diagnostic Parameters. The sequencer function consists of 16 step segments, each individual step segment can have its own ramp time, time spent in individual segment and output frequency entered. The sequencer has 3 different modes to control how the drive moves through each individual step segment: Timer Transition, Step Sequence or Timer and Step Sequence.

### P700= 1 (Timer Transition)

Starting at the segment number entered in the "Start Segment" parameter, the drive will automatically move through each of the segments. The time spent in each segment is determined by the values set in the individual "Time in Current Step" parameters.

### P700= 2 (Step Sequence)

Starting at the segment number entered in the "Start Segment" parameter the sequencer will only move to the next segment when a rising edge is applied to the highest priority digital input which is programmed to "Step Sequence" selection "24".

### P700= 3 (Timer Transition or Step Sequence)

Starting at the segment number entered in the "Start Segment" parameter, the drive will automatically move through each of the segments. The time spent in each segment is determined by the values set in the individual "Time in Current Step" parameters, however if a rising edge is applied to the highest priority digital input which is programmed to "Step Sequence" selection "24" it will force the sequencer to step into the next segment.

**NOTE:** A value of "0" in the "Time in current step" parameter (ex: P712), will result in the segment being skipped.

| Code                |  | Possible Settings |  | IMPORTANT   |
|---------------------|--|-------------------|--|---|
| No.                 | Name   | Default           | Selection  |   |
| P700                | Sequencer Mode   | 0                 | 0 Disabled<br>1 Enabled: transition on timer only<br>2 Enabled: transition on rising edge (P121, 122, 123 = 25 step sequence)<br>3 Enabled: transition on timer or rising edge | If P700 = 0 and no reference (P121, P101) points to any of the sequence segments, then P701-P799 will not be displayed on the local keypad. |
| P701                | Sequencer: TB13A Trigger Segment                               | 1                 | 1 - 16<br>TB13A = lowest priority  | Asserting TB13A with selection #24 (Start Sequence), starts the sequence operation from the segment specified in this parameter.            |
| P702                | Sequencer: TB13B Trigger Segment                               | 1                 | 1 - 16<br>TB13B: higher priority than TB13A  | Asserting TB13B with selection #24 (Start Sequence), starts the sequence operation from the segment specified in this parameter.            |
| P703                | Sequencer: TB13C Trigger Segment                               | 1                 | 1 - 16<br>TB13C: higher priority than TB13B, A   | Asserting TB13C with selection #24 (Start Sequence), starts the sequence operation from the segment specified in this parameter.            |
| P704 <sup>(2)</sup> | Sequencer: TB13D Trigger Segment                               | 1                 | 1 - 16<br>TB13D: higher priority than TB13C, B, A  | Asserting TB13D with selection #24 (Start Sequence), starts the sequence operation from the segment specified in this parameter.            |
| P706                | Sequencer: Action after Stop/Start transition or Fault Restart | 0                 | 0 Restart at beginning of sequence<br>1 Restart at beginning of current seg<br>2 Start at beginning of prior segment<br>3 Start at beginning of next segment                   | Pointed by TB13x  |
| P707                | Sequencer: Number of cycles                                    | 1                 | 1 65535  | 1 = single scan; 65535 = continuous loop  |

(2) Parameter applicable to SMV models 15HP (11kW) and higher.



## Commissioning

| Code                     |                                     | Possible Settings  |   |                  |                 | IMPORTANT  |   |   |   |   |   |   |   |   |               |   |   |   |   |   |   |   |   |              |   |   |   |   |   |   |   |   |                          |   |   |   |   |   |   |   |   |   |
|--------------------------|-------------------------------------|--|---|------------------|-----------------|--|---|---|---|---|---|---|---|---|---------------|---|---|---|---|---|---|---|---|--------------|---|---|---|---|---|---|---|---|--------------------------|---|---|---|---|---|---|---|---|---|
| No.                      | Name                                | Default  | Selection   |                  |                 |  |   |   |   |   |   |   |   |   |               |   |   |   |   |   |   |   |   |              |   |   |   |   |   |   |   |   |                          |   |   |   |   |   |   |   |   |   |
| P708                     | Sequencer: Time units/scaling       | 0  | 0   | 0.1              | (sec)           | 6553.5   | Setup units/scaling for all sequencer time related parameters |   |   |   |   |   |   |   |               |   |   |   |   |   |   |   |   |              |   |   |   |   |   |   |   |   |                          |   |   |   |   |   |   |   |   |   |
|                          |                                     |  | 1   | 1                | (sec)           | 65535  |   |   |   |   |   |   |   |   |               |   |   |   |   |   |   |   |   |              |   |   |   |   |   |   |   |   |                          |   |   |   |   |   |   |   |   |   |
|                          |                                     |  | 2   | 1                | (min)           | 65535  |   |   |   |   |   |   |   |   |               |   |   |   |   |   |   |   |   |              |   |   |   |   |   |   |   |   |                          |   |   |   |   |   |   |   |   |   |
|                          |                                     | <b>NOTE:</b><br>P708 rescales the following sequencer related parameters:<br>- Segment Times in current step: P712, P717, P722, P727, P732, P737, P742, P747, P752, P757, P762, P767, P772, P777, P782, P787, P792<br>- Sequence diagnostic/status: P561, P562 |   |                  |                 |  |   |   |   |   |   |   |   |   |               |   |   |   |   |   |   |   |   |              |   |   |   |   |   |   |   |   |                          |   |   |   |   |   |   |   |   |   |
| <b>Segment #1</b>        |                                     |  |   |                  |                 |  |   |   |   |   |   |   |   |   |               |   |   |   |   |   |   |   |   |              |   |   |   |   |   |   |   |   |                          |   |   |   |   |   |   |   |   |   |
| P710                     | Segment #1 Frequency Setpoint       | 0.0  | -500.0  | (Hz)             | 500.0           | If P112 = 1, negative sign forces reverse direction                      |   |   |   |   |   |   |   |   |               |   |   |   |   |   |   |   |   |              |   |   |   |   |   |   |   |   |                          |   |   |   |   |   |   |   |   |   |
| P711                     | Segment #1 Accel/Decel Time         | 20.0   | 0.0   | (sec)            | 3600.0          |  |   |   |   |   |   |   |   |   |               |   |   |   |   |   |   |   |   |              |   |   |   |   |   |   |   |   |                          |   |   |   |   |   |   |   |   |   |
| P712                     | Segment #1 Time in current step     | 0.0<br>0   | 0.0<br>0  | (P708)<br>(P708) | 6553.5<br>65535 | Scaling/units depend on P708<br>Skip segment if time = 0                 |   |   |   |   |   |   |   |   |               |   |   |   |   |   |   |   |   |              |   |   |   |   |   |   |   |   |                          |   |   |   |   |   |   |   |   |   |
| P713                     | Segment #1 Digital Output State     | 0  | <table border="1" style="font-size: small;"> <tr><td>Value set in P713</td><td>0</td><td>1</td><td>2</td><td>3</td><td>4</td><td>5</td><td>6</td><td>7</td></tr> <tr><td>Relay (Bit 0)</td><td>0</td><td>1</td><td>0</td><td>1</td><td>0</td><td>1</td><td>0</td><td>1</td></tr> <tr><td>TB14 (Bit 1)</td><td>0</td><td>0</td><td>1</td><td>1</td><td>0</td><td>0</td><td>1</td><td>1</td></tr> <tr><td>I/O option Relay (Bit 2)</td><td>0</td><td>0</td><td>0</td><td>0</td><td>1</td><td>1</td><td>1</td><td>1</td></tr> </table> |                  |                 | Value set in P713  | 0   | 1 | 2 | 3 | 4 | 5 | 6 | 7 | Relay (Bit 0) | 0 | 1 | 0 | 1 | 0 | 1 | 0 | 1 | TB14 (Bit 1) | 0 | 0 | 1 | 1 | 0 | 0 | 1 | 1 | I/O option Relay (Bit 2) | 0 | 0 | 0 | 0 | 1 | 1 | 1 | 1 | bit = 0: OFF (De-energized)<br>bit = 1: ON (Energized)<br>The corresponding digital output/relay must be set to accept data from the sequencer: P140, P142, P441 = 27 |
| Value set in P713        | 0                                   | 1  | 2   | 3                | 4               | 5  | 6   | 7 |   |   |   |   |   |   |               |   |   |   |   |   |   |   |   |              |   |   |   |   |   |   |   |   |                          |   |   |   |   |   |   |   |   |   |
| Relay (Bit 0)            | 0                                   | 1  | 0   | 1                | 0               | 1  | 0   | 1 |   |   |   |   |   |   |               |   |   |   |   |   |   |   |   |              |   |   |   |   |   |   |   |   |                          |   |   |   |   |   |   |   |   |   |
| TB14 (Bit 1)             | 0                                   | 0  | 1   | 1                | 0               | 0  | 1   | 1 |   |   |   |   |   |   |               |   |   |   |   |   |   |   |   |              |   |   |   |   |   |   |   |   |                          |   |   |   |   |   |   |   |   |   |
| I/O option Relay (Bit 2) | 0                                   | 0  | 0   | 0                | 1               | 1  | 1   | 1 |   |   |   |   |   |   |               |   |   |   |   |   |   |   |   |              |   |   |   |   |   |   |   |   |                          |   |   |   |   |   |   |   |   |   |
| P714                     | Segment #1 TB30 Analog Output Value | 0.00   | 0.00  | (VDC)            | 10.00           | TB30 configuration parameter must be set to accept this value: P150 = 10 |   |   |   |   |   |   |   |   |               |   |   |   |   |   |   |   |   |              |   |   |   |   |   |   |   |   |                          |   |   |   |   |   |   |   |   |   |
| <b>Segment #2</b>        |                                     |  |   |                  |                 |  |   |   |   |   |   |   |   |   |               |   |   |   |   |   |   |   |   |              |   |   |   |   |   |   |   |   |                          |   |   |   |   |   |   |   |   |   |
| P715                     | Segment #2 Frequency Setpoint       | 0.0  | -500.0  | (Hz)             | 500.0           | If P112 = 1, negative sign forces reverse direction                      |   |   |   |   |   |   |   |   |               |   |   |   |   |   |   |   |   |              |   |   |   |   |   |   |   |   |                          |   |   |   |   |   |   |   |   |   |
| P716                     | Segment #2 Accel/Decel Time         | 20.0   | 0.0   | (sec)            | 3600.0          |  |   |   |   |   |   |   |   |   |               |   |   |   |   |   |   |   |   |              |   |   |   |   |   |   |   |   |                          |   |   |   |   |   |   |   |   |   |
| P717                     | Segment #2 Time in current step     | 0.0<br>0   | 0.0<br>0  | (P708)<br>(P708) | 6553.5<br>65535 | Scaling/units depend on P708<br>Skip segment if time = 0                 |   |   |   |   |   |   |   |   |               |   |   |   |   |   |   |   |   |              |   |   |   |   |   |   |   |   |                          |   |   |   |   |   |   |   |   |   |
| P718                     | Segment #2 Digital Output State     | 0  | <table border="1" style="font-size: small;"> <tr><td>Value set in P718</td><td>0</td><td>1</td><td>2</td><td>3</td><td>4</td><td>5</td><td>6</td><td>7</td></tr> <tr><td>Relay (Bit 0)</td><td>0</td><td>1</td><td>0</td><td>1</td><td>0</td><td>1</td><td>0</td><td>1</td></tr> <tr><td>TB14 (Bit 1)</td><td>0</td><td>0</td><td>1</td><td>1</td><td>0</td><td>0</td><td>1</td><td>1</td></tr> <tr><td>I/O option Relay (Bit 2)</td><td>0</td><td>0</td><td>0</td><td>0</td><td>1</td><td>1</td><td>1</td><td>1</td></tr> </table> |                  |                 | Value set in P718  | 0   | 1 | 2 | 3 | 4 | 5 | 6 | 7 | Relay (Bit 0) | 0 | 1 | 0 | 1 | 0 | 1 | 0 | 1 | TB14 (Bit 1) | 0 | 0 | 1 | 1 | 0 | 0 | 1 | 1 | I/O option Relay (Bit 2) | 0 | 0 | 0 | 0 | 1 | 1 | 1 | 1 | bit = 0: OFF (De-energized)<br>bit = 1: ON (Energized)<br>The corresponding digital output/relay must be set to accept data from the sequencer: P140, P142, P441 = 27 |
| Value set in P718        | 0                                   | 1  | 2   | 3                | 4               | 5  | 6   | 7 |   |   |   |   |   |   |               |   |   |   |   |   |   |   |   |              |   |   |   |   |   |   |   |   |                          |   |   |   |   |   |   |   |   |   |
| Relay (Bit 0)            | 0                                   | 1  | 0   | 1                | 0               | 1  | 0   | 1 |   |   |   |   |   |   |               |   |   |   |   |   |   |   |   |              |   |   |   |   |   |   |   |   |                          |   |   |   |   |   |   |   |   |   |
| TB14 (Bit 1)             | 0                                   | 0  | 1   | 1                | 0               | 0  | 1   | 1 |   |   |   |   |   |   |               |   |   |   |   |   |   |   |   |              |   |   |   |   |   |   |   |   |                          |   |   |   |   |   |   |   |   |   |
| I/O option Relay (Bit 2) | 0                                   | 0  | 0   | 0                | 1               | 1  | 1   | 1 |   |   |   |   |   |   |               |   |   |   |   |   |   |   |   |              |   |   |   |   |   |   |   |   |                          |   |   |   |   |   |   |   |   |   |
| P719                     | Segment #2 TB30 Analog Output Value | 0.00   | 0.00  | (VDC)            | 10.00           | TB30 configuration parameter must be set to accept this value: P150 = 10 |   |   |   |   |   |   |   |   |               |   |   |   |   |   |   |   |   |              |   |   |   |   |   |   |   |   |                          |   |   |   |   |   |   |   |   |   |

# Commissioning



| Code                    |                                     | Possible Settings |   |                               | IMPORTANT  |   |   |   |   |   |   |   |   |              |   |   |   |   |   |   |   |   |             |   |   |   |   |   |   |   |   |                         |   |   |   |   |   |   |   |   |   |
|-------------------------|-------------------------------------|-------------------|---|-------------------------------|--|---|---|---|---|---|---|---|---|--------------|---|---|---|---|---|---|---|---|-------------|---|---|---|---|---|---|---|---|-------------------------|---|---|---|---|---|---|---|---|---|
| No.                     | Name                                | Default           | Selection   |                               |  |   |   |   |   |   |   |   |   |              |   |   |   |   |   |   |   |   |             |   |   |   |   |   |   |   |   |                         |   |   |   |   |   |   |   |   |   |
| <b>Segment #3</b>       |                                     |                   |   |                               |  |   |   |   |   |   |   |   |   |              |   |   |   |   |   |   |   |   |             |   |   |   |   |   |   |   |   |                         |   |   |   |   |   |   |   |   |   |
| P120                    | Segment #3 Frequency Setpoint       | 0.0               | -500.0  | (Hz) 500.0                    | If P112 = 1, negative sign forces reverse direction                      |   |   |   |   |   |   |   |   |              |   |   |   |   |   |   |   |   |             |   |   |   |   |   |   |   |   |                         |   |   |   |   |   |   |   |   |   |
| P121                    | Segment #3 Accel/Decel Time         | 20.0              | 0.0   | (sec) 3600.0                  |  |   |   |   |   |   |   |   |   |              |   |   |   |   |   |   |   |   |             |   |   |   |   |   |   |   |   |                         |   |   |   |   |   |   |   |   |   |
| P122                    | Segment #3 Time in current step     | 0.0<br>0          | 0.0<br>0  | (P708) 6553.5<br>(P708) 65535 | Scaling/units depend on P708<br>Skip segment if time = 0                 |   |   |   |   |   |   |   |   |              |   |   |   |   |   |   |   |   |             |   |   |   |   |   |   |   |   |                         |   |   |   |   |   |   |   |   |   |
| P123                    | Segment #3 Digital Output State     | 0                 | <table border="1"> <tr> <td>Value set in P723</td> <td>0</td><td>1</td><td>2</td><td>3</td><td>4</td><td>5</td><td>6</td><td>7</td> </tr> <tr> <td>Relay (BA 0)</td> <td>0</td><td>1</td><td>0</td><td>1</td><td>0</td><td>1</td><td>0</td><td>1</td> </tr> <tr> <td>TB14 (BA 1)</td> <td>0</td><td>0</td><td>1</td><td>1</td><td>0</td><td>0</td><td>1</td><td>1</td> </tr> <tr> <td>I/O option Relay (BA 2)</td> <td>0</td><td>0</td><td>0</td><td>0</td><td>1</td><td>1</td><td>1</td><td>1</td> </tr> </table> <p>NOTE: P441 is the Relay Output (TB-19, 20, 21) of the optional Digital I/O module (ESVZALO, ESVZAL1).</p> |                               | Value set in P723  | 0 | 1 | 2 | 3 | 4 | 5 | 6 | 7 | Relay (BA 0) | 0 | 1 | 0 | 1 | 0 | 1 | 0 | 1 | TB14 (BA 1) | 0 | 0 | 1 | 1 | 0 | 0 | 1 | 1 | I/O option Relay (BA 2) | 0 | 0 | 0 | 0 | 1 | 1 | 1 | 1 | bit = 0: OFF (De-energized)<br>bit = 1: ON (Energized)<br>The corresponding digital output/relay must be set to accept data from the sequencer: P140, P142, P441 = 27 |
| Value set in P723       | 0                                   | 1                 | 2   | 3                             | 4  | 5 | 6 | 7 |   |   |   |   |   |              |   |   |   |   |   |   |   |   |             |   |   |   |   |   |   |   |   |                         |   |   |   |   |   |   |   |   |   |
| Relay (BA 0)            | 0                                   | 1                 | 0   | 1                             | 0  | 1 | 0 | 1 |   |   |   |   |   |              |   |   |   |   |   |   |   |   |             |   |   |   |   |   |   |   |   |                         |   |   |   |   |   |   |   |   |   |
| TB14 (BA 1)             | 0                                   | 0                 | 1   | 1                             | 0  | 0 | 1 | 1 |   |   |   |   |   |              |   |   |   |   |   |   |   |   |             |   |   |   |   |   |   |   |   |                         |   |   |   |   |   |   |   |   |   |
| I/O option Relay (BA 2) | 0                                   | 0                 | 0   | 0                             | 1  | 1 | 1 | 1 |   |   |   |   |   |              |   |   |   |   |   |   |   |   |             |   |   |   |   |   |   |   |   |                         |   |   |   |   |   |   |   |   |   |
| P124                    | Segment #3 TB30 Analog Output Value | 0.00              | 0.00  | (VDC) 10.00                   | TB30 configuration parameter must be set to accept this value: P150 = 10 |   |   |   |   |   |   |   |   |              |   |   |   |   |   |   |   |   |             |   |   |   |   |   |   |   |   |                         |   |   |   |   |   |   |   |   |   |
| <b>Segment #4</b>       |                                     |                   |   |                               |  |   |   |   |   |   |   |   |   |              |   |   |   |   |   |   |   |   |             |   |   |   |   |   |   |   |   |                         |   |   |   |   |   |   |   |   |   |
| P125                    | Segment #4 Frequency Setpoint       | 0.0               | -500.0  | (Hz) 500.0                    | If P112 = 1, negative sign forces reverse direction                      |   |   |   |   |   |   |   |   |              |   |   |   |   |   |   |   |   |             |   |   |   |   |   |   |   |   |                         |   |   |   |   |   |   |   |   |   |
| P126                    | Segment #4 Accel/Decel Time         | 20.0              | 0.0   | (sec) 3600.0                  |  |   |   |   |   |   |   |   |   |              |   |   |   |   |   |   |   |   |             |   |   |   |   |   |   |   |   |                         |   |   |   |   |   |   |   |   |   |
| P127                    | Segment #4 Time in current step     | 0.0<br>0          | 0.0<br>0  | (P708) 6553.5<br>(P708) 65535 | Scaling/units depend on P708<br>Skip segment if time = 0                 |   |   |   |   |   |   |   |   |              |   |   |   |   |   |   |   |   |             |   |   |   |   |   |   |   |   |                         |   |   |   |   |   |   |   |   |   |
| P128                    | Segment #4 Digital Output State     | 0                 | <table border="1"> <tr> <td>Value set in P728</td> <td>0</td><td>1</td><td>2</td><td>3</td><td>4</td><td>5</td><td>6</td><td>7</td> </tr> <tr> <td>Relay (BA 0)</td> <td>0</td><td>1</td><td>0</td><td>1</td><td>0</td><td>1</td><td>0</td><td>1</td> </tr> <tr> <td>TB14 (BA 1)</td> <td>0</td><td>0</td><td>1</td><td>1</td><td>0</td><td>0</td><td>1</td><td>1</td> </tr> <tr> <td>I/O option Relay (BA 2)</td> <td>0</td><td>0</td><td>0</td><td>0</td><td>1</td><td>1</td><td>1</td><td>1</td> </tr> </table> <p>NOTE: P441 is the Relay Output (TB-19, 20, 21) of the optional Digital I/O module (ESVZALO, ESVZAL1).</p> |                               | Value set in P728  | 0 | 1 | 2 | 3 | 4 | 5 | 6 | 7 | Relay (BA 0) | 0 | 1 | 0 | 1 | 0 | 1 | 0 | 1 | TB14 (BA 1) | 0 | 0 | 1 | 1 | 0 | 0 | 1 | 1 | I/O option Relay (BA 2) | 0 | 0 | 0 | 0 | 1 | 1 | 1 | 1 | bit = 0: OFF (De-energized)<br>bit = 1: ON (Energized)<br>The corresponding digital output/relay must be set to accept data from the sequencer: P140, P142, P441 = 27 |
| Value set in P728       | 0                                   | 1                 | 2   | 3                             | 4  | 5 | 6 | 7 |   |   |   |   |   |              |   |   |   |   |   |   |   |   |             |   |   |   |   |   |   |   |   |                         |   |   |   |   |   |   |   |   |   |
| Relay (BA 0)            | 0                                   | 1                 | 0   | 1                             | 0  | 1 | 0 | 1 |   |   |   |   |   |              |   |   |   |   |   |   |   |   |             |   |   |   |   |   |   |   |   |                         |   |   |   |   |   |   |   |   |   |
| TB14 (BA 1)             | 0                                   | 0                 | 1   | 1                             | 0  | 0 | 1 | 1 |   |   |   |   |   |              |   |   |   |   |   |   |   |   |             |   |   |   |   |   |   |   |   |                         |   |   |   |   |   |   |   |   |   |
| I/O option Relay (BA 2) | 0                                   | 0                 | 0   | 0                             | 1  | 1 | 1 | 1 |   |   |   |   |   |              |   |   |   |   |   |   |   |   |             |   |   |   |   |   |   |   |   |                         |   |   |   |   |   |   |   |   |   |
| P129                    | Segment #4 TB30 Analog Output Value | 0.00              | 0.00  | (VDC) 10.00                   | TB30 configuration parameter must be set to accept this value: P150 = 10 |   |   |   |   |   |   |   |   |              |   |   |   |   |   |   |   |   |             |   |   |   |   |   |   |   |   |                         |   |   |   |   |   |   |   |   |   |
| <b>Segment #5</b>       |                                     |                   |   |                               |  |   |   |   |   |   |   |   |   |              |   |   |   |   |   |   |   |   |             |   |   |   |   |   |   |   |   |                         |   |   |   |   |   |   |   |   |   |
| P130                    | Segment #5 Frequency Setpoint       | 0.0               | -500.0  | (Hz) 500.0                    | If P112 = 1, negative sign forces reverse direction                      |   |   |   |   |   |   |   |   |              |   |   |   |   |   |   |   |   |             |   |   |   |   |   |   |   |   |                         |   |   |   |   |   |   |   |   |   |
| P131                    | Segment #5 Accel/Decel Time         | 20.0              | 0.0   | (sec) 3600.0                  |  |   |   |   |   |   |   |   |   |              |   |   |   |   |   |   |   |   |             |   |   |   |   |   |   |   |   |                         |   |   |   |   |   |   |   |   |   |
| P132                    | Segment #5 Time in current step     | 0.0<br>0          | 0.0<br>0  | (P708) 6553.5<br>(P708) 65535 | Scaling/units depend on P708<br>Skip segment if time = 0                 |   |   |   |   |   |   |   |   |              |   |   |   |   |   |   |   |   |             |   |   |   |   |   |   |   |   |                         |   |   |   |   |   |   |   |   |   |
| P133                    | Segment #5 Digital Output State     | 0                 | <table border="1"> <tr> <td>Value set in P733</td> <td>0</td><td>1</td><td>2</td><td>3</td><td>4</td><td>5</td><td>6</td><td>7</td> </tr> <tr> <td>Relay (BA 0)</td> <td>0</td><td>1</td><td>0</td><td>1</td><td>0</td><td>1</td><td>0</td><td>1</td> </tr> <tr> <td>TB14 (BA 1)</td> <td>0</td><td>0</td><td>1</td><td>1</td><td>0</td><td>0</td><td>1</td><td>1</td> </tr> <tr> <td>I/O option Relay (BA 2)</td> <td>0</td><td>0</td><td>0</td><td>0</td><td>1</td><td>1</td><td>1</td><td>1</td> </tr> </table> <p>NOTE: P441 is the Relay Output (TB-19, 20, 21) of the optional Digital I/O module (ESVZALO, ESVZAL1).</p> |                               | Value set in P733  | 0 | 1 | 2 | 3 | 4 | 5 | 6 | 7 | Relay (BA 0) | 0 | 1 | 0 | 1 | 0 | 1 | 0 | 1 | TB14 (BA 1) | 0 | 0 | 1 | 1 | 0 | 0 | 1 | 1 | I/O option Relay (BA 2) | 0 | 0 | 0 | 0 | 1 | 1 | 1 | 1 | bit = 0: OFF (De-energized)<br>bit = 1: ON (Energized)<br>The corresponding digital output/relay must be set to accept data from the sequencer: P140, P142, P441 = 27 |
| Value set in P733       | 0                                   | 1                 | 2   | 3                             | 4  | 5 | 6 | 7 |   |   |   |   |   |              |   |   |   |   |   |   |   |   |             |   |   |   |   |   |   |   |   |                         |   |   |   |   |   |   |   |   |   |
| Relay (BA 0)            | 0                                   | 1                 | 0   | 1                             | 0  | 1 | 0 | 1 |   |   |   |   |   |              |   |   |   |   |   |   |   |   |             |   |   |   |   |   |   |   |   |                         |   |   |   |   |   |   |   |   |   |
| TB14 (BA 1)             | 0                                   | 0                 | 1   | 1                             | 0  | 0 | 1 | 1 |   |   |   |   |   |              |   |   |   |   |   |   |   |   |             |   |   |   |   |   |   |   |   |                         |   |   |   |   |   |   |   |   |   |
| I/O option Relay (BA 2) | 0                                   | 0                 | 0   | 0                             | 1  | 1 | 1 | 1 |   |   |   |   |   |              |   |   |   |   |   |   |   |   |             |   |   |   |   |   |   |   |   |                         |   |   |   |   |   |   |   |   |   |
| P134                    | Segment #5 TB30 Analog Output Value | 0.00              | 0.00  | (VDC) 10.00                   | TB30 configuration parameter must be set to accept this value: P150 = 10 |   |   |   |   |   |   |   |   |              |   |   |   |   |   |   |   |   |             |   |   |   |   |   |   |   |   |                         |   |   |   |   |   |   |   |   |   |





## Commissioning

| Code                     |  | Possible Settings |  |                 | IMPORTANT  |   |   |   |   |   |   |   |   |              |   |   |   |   |   |   |   |   |             |   |   |   |   |   |   |   |   |                          |   |   |   |   |   |   |   |   |   |
|--------------------------|--|-------------------|--|-----------------|--|---|---|---|---|---|---|---|---|--------------|---|---|---|---|---|---|---|---|-------------|---|---|---|---|---|---|---|---|--------------------------|---|---|---|---|---|---|---|---|---|
| No.                      | Name                                   | Default           | Selection  |                 |  |   |   |   |   |   |   |   |   |              |   |   |   |   |   |   |   |   |             |   |   |   |   |   |   |   |   |                          |   |   |   |   |   |   |   |   |   |
| <b>Segment #6</b>        |  |                   |  |                 |  |   |   |   |   |   |   |   |   |              |   |   |   |   |   |   |   |   |             |   |   |   |   |   |   |   |   |                          |   |   |   |   |   |   |   |   |   |
| P735                     | Segment #6<br>Frequency Setpoint       | 0.0               | -500.0 (Hz)  | 500.0           | If P112 = 1, negative sign forces reverse direction                      |   |   |   |   |   |   |   |   |              |   |   |   |   |   |   |   |   |             |   |   |   |   |   |   |   |   |                          |   |   |   |   |   |   |   |   |   |
| P736                     | Segment #6<br>Accel/Decel Time         | 20.0              | 0.0 (sec)  | 3600.0          |  |   |   |   |   |   |   |   |   |              |   |   |   |   |   |   |   |   |             |   |   |   |   |   |   |   |   |                          |   |   |   |   |   |   |   |   |   |
| P737                     | Segment #6<br>Time in current step     | 0.0<br>0          | 0.0 (P708)<br>0 (P708)   | 6553.5<br>65535 | Scaling/units depend on P708<br>Skip segment if time = 0                 |   |   |   |   |   |   |   |   |              |   |   |   |   |   |   |   |   |             |   |   |   |   |   |   |   |   |                          |   |   |   |   |   |   |   |   |   |
| P738                     | Segment #6<br>Digital Output State     | 0                 | <table border="1" style="font-size: small;"> <tr> <td>Value set in P738</td> <td>0</td><td>1</td><td>2</td><td>3</td><td>4</td><td>5</td><td>6</td><td>7</td> </tr> <tr> <td>Relay (BR 0)</td> <td>0</td><td>1</td><td>0</td><td>1</td><td>0</td><td>1</td><td>0</td><td>1</td> </tr> <tr> <td>TB14 (BR 1)</td> <td>0</td><td>0</td><td>1</td><td>1</td><td>0</td><td>0</td><td>1</td><td>1</td> </tr> <tr> <td>I/O option Relay (Bit 2)</td> <td>0</td><td>0</td><td>0</td><td>0</td><td>1</td><td>1</td><td>1</td><td>1</td> </tr> </table> <p style="font-size: x-small;">NOTE: P441 is the Relay Output (TB-19, 20, 21) of the optional Digital I/O module (ESVZAL0, ESVZAL1).</p> |                 | Value set in P738  | 0 | 1 | 2 | 3 | 4 | 5 | 6 | 7 | Relay (BR 0) | 0 | 1 | 0 | 1 | 0 | 1 | 0 | 1 | TB14 (BR 1) | 0 | 0 | 1 | 1 | 0 | 0 | 1 | 1 | I/O option Relay (Bit 2) | 0 | 0 | 0 | 0 | 1 | 1 | 1 | 1 | bit = 0: OFF (De-energized)<br>bit = 1: ON (Energized)<br>The corresponding digital output/relay must be set to accept data from the sequencer: P140, P142, P441 = 27 |
| Value set in P738        | 0                                      | 1                 | 2  | 3               | 4  | 5 | 6 | 7 |   |   |   |   |   |              |   |   |   |   |   |   |   |   |             |   |   |   |   |   |   |   |   |                          |   |   |   |   |   |   |   |   |   |
| Relay (BR 0)             | 0                                      | 1                 | 0  | 1               | 0  | 1 | 0 | 1 |   |   |   |   |   |              |   |   |   |   |   |   |   |   |             |   |   |   |   |   |   |   |   |                          |   |   |   |   |   |   |   |   |   |
| TB14 (BR 1)              | 0                                      | 0                 | 1  | 1               | 0  | 0 | 1 | 1 |   |   |   |   |   |              |   |   |   |   |   |   |   |   |             |   |   |   |   |   |   |   |   |                          |   |   |   |   |   |   |   |   |   |
| I/O option Relay (Bit 2) | 0                                      | 0                 | 0  | 0               | 1  | 1 | 1 | 1 |   |   |   |   |   |              |   |   |   |   |   |   |   |   |             |   |   |   |   |   |   |   |   |                          |   |   |   |   |   |   |   |   |   |
| P739                     | Segment #6 TB30<br>Analog Output Value | 0.00              | 0.00 (VDC)   | 10.00           | TB30 configuration parameter must be set to accept this value: P150 = 10 |   |   |   |   |   |   |   |   |              |   |   |   |   |   |   |   |   |             |   |   |   |   |   |   |   |   |                          |   |   |   |   |   |   |   |   |   |
| <b>Segment #7</b>        |  |                   |  |                 |  |   |   |   |   |   |   |   |   |              |   |   |   |   |   |   |   |   |             |   |   |   |   |   |   |   |   |                          |   |   |   |   |   |   |   |   |   |
| P740                     | Segment #7<br>Frequency Setpoint       | 0.0               | -500.0 (Hz)  | 500.0           | If P112 = 1, negative sign forces reverse direction                      |   |   |   |   |   |   |   |   |              |   |   |   |   |   |   |   |   |             |   |   |   |   |   |   |   |   |                          |   |   |   |   |   |   |   |   |   |
| P741                     | Segment #7<br>Accel/Decel Time         | 20.0              | 0.0 (sec)  | 3600.0          |  |   |   |   |   |   |   |   |   |              |   |   |   |   |   |   |   |   |             |   |   |   |   |   |   |   |   |                          |   |   |   |   |   |   |   |   |   |
| P742                     | Segment #7<br>Time in current step     | 0.0<br>0          | 0.0 (P708)<br>0 (P708)   | 6553.5<br>65535 | Scaling/units depend on P708<br>Skip segment if time = 0                 |   |   |   |   |   |   |   |   |              |   |   |   |   |   |   |   |   |             |   |   |   |   |   |   |   |   |                          |   |   |   |   |   |   |   |   |   |
| P743                     | Segment #7<br>Digital Output State     | 0                 | <table border="1" style="font-size: small;"> <tr> <td>Value set in P743</td> <td>0</td><td>1</td><td>2</td><td>3</td><td>4</td><td>5</td><td>6</td><td>7</td> </tr> <tr> <td>Relay (BR 0)</td> <td>0</td><td>1</td><td>0</td><td>1</td><td>0</td><td>1</td><td>0</td><td>1</td> </tr> <tr> <td>TB14 (BR 1)</td> <td>0</td><td>0</td><td>1</td><td>1</td><td>0</td><td>0</td><td>1</td><td>1</td> </tr> <tr> <td>I/O option Relay (Bit 2)</td> <td>0</td><td>0</td><td>0</td><td>0</td><td>1</td><td>1</td><td>1</td><td>1</td> </tr> </table> <p style="font-size: x-small;">NOTE: P441 is the Relay Output (TB-19, 20, 21) of the optional Digital I/O module (ESVZAL0, ESVZAL1).</p> |                 | Value set in P743  | 0 | 1 | 2 | 3 | 4 | 5 | 6 | 7 | Relay (BR 0) | 0 | 1 | 0 | 1 | 0 | 1 | 0 | 1 | TB14 (BR 1) | 0 | 0 | 1 | 1 | 0 | 0 | 1 | 1 | I/O option Relay (Bit 2) | 0 | 0 | 0 | 0 | 1 | 1 | 1 | 1 | bit = 0: OFF (De-energized)<br>bit = 1: ON (Energized)<br>The corresponding digital output/relay must be set to accept data from the sequencer: P140, P142, P441 = 27 |
| Value set in P743        | 0                                      | 1                 | 2  | 3               | 4  | 5 | 6 | 7 |   |   |   |   |   |              |   |   |   |   |   |   |   |   |             |   |   |   |   |   |   |   |   |                          |   |   |   |   |   |   |   |   |   |
| Relay (BR 0)             | 0                                      | 1                 | 0  | 1               | 0  | 1 | 0 | 1 |   |   |   |   |   |              |   |   |   |   |   |   |   |   |             |   |   |   |   |   |   |   |   |                          |   |   |   |   |   |   |   |   |   |
| TB14 (BR 1)              | 0                                      | 0                 | 1  | 1               | 0  | 0 | 1 | 1 |   |   |   |   |   |              |   |   |   |   |   |   |   |   |             |   |   |   |   |   |   |   |   |                          |   |   |   |   |   |   |   |   |   |
| I/O option Relay (Bit 2) | 0                                      | 0                 | 0  | 0               | 1  | 1 | 1 | 1 |   |   |   |   |   |              |   |   |   |   |   |   |   |   |             |   |   |   |   |   |   |   |   |                          |   |   |   |   |   |   |   |   |   |
| P744                     | Segment #7 TB30<br>Analog Output Value | 0.00              | 0.00 (VDC)   | 10.00           | TB30 configuration parameter must be set to accept this value: P150 = 10 |   |   |   |   |   |   |   |   |              |   |   |   |   |   |   |   |   |             |   |   |   |   |   |   |   |   |                          |   |   |   |   |   |   |   |   |   |
| <b>Segment #8</b>        |  |                   |  |                 |  |   |   |   |   |   |   |   |   |              |   |   |   |   |   |   |   |   |             |   |   |   |   |   |   |   |   |                          |   |   |   |   |   |   |   |   |   |
| P745                     | Segment #8<br>Frequency Setpoint       | 0.0               | -500.0 (Hz)  | 500.0           | If P112 = 1, negative sign forces reverse direction                      |   |   |   |   |   |   |   |   |              |   |   |   |   |   |   |   |   |             |   |   |   |   |   |   |   |   |                          |   |   |   |   |   |   |   |   |   |
| P746                     | Segment #8<br>Accel/Decel Time         | 20.0              | 0.0 (sec)  | 3600.0          |  |   |   |   |   |   |   |   |   |              |   |   |   |   |   |   |   |   |             |   |   |   |   |   |   |   |   |                          |   |   |   |   |   |   |   |   |   |
| P747                     | Segment #8<br>Time in current step     | 0.0<br>0          | 0.0 (P708)<br>0 (P708)   | 6553.5<br>65535 | Scaling/units depend on P708<br>Skip segment if time = 0                 |   |   |   |   |   |   |   |   |              |   |   |   |   |   |   |   |   |             |   |   |   |   |   |   |   |   |                          |   |   |   |   |   |   |   |   |   |
| P748                     | Segment #8<br>Digital Output State     | 0                 | <table border="1" style="font-size: small;"> <tr> <td>Value set in P748</td> <td>0</td><td>1</td><td>2</td><td>3</td><td>4</td><td>5</td><td>6</td><td>7</td> </tr> <tr> <td>Relay (BR 0)</td> <td>0</td><td>1</td><td>0</td><td>1</td><td>0</td><td>1</td><td>0</td><td>1</td> </tr> <tr> <td>TB14 (BR 1)</td> <td>0</td><td>0</td><td>1</td><td>1</td><td>0</td><td>0</td><td>1</td><td>1</td> </tr> <tr> <td>I/O option Relay (Bit 2)</td> <td>0</td><td>0</td><td>0</td><td>0</td><td>1</td><td>1</td><td>1</td><td>1</td> </tr> </table> <p style="font-size: x-small;">NOTE: P441 is the Relay Output (TB-19, 20, 21) of the optional Digital I/O module (ESVZAL0, ESVZAL1).</p> |                 | Value set in P748  | 0 | 1 | 2 | 3 | 4 | 5 | 6 | 7 | Relay (BR 0) | 0 | 1 | 0 | 1 | 0 | 1 | 0 | 1 | TB14 (BR 1) | 0 | 0 | 1 | 1 | 0 | 0 | 1 | 1 | I/O option Relay (Bit 2) | 0 | 0 | 0 | 0 | 1 | 1 | 1 | 1 | bit = 0: OFF (De-energized)<br>bit = 1: ON (Energized)<br>The corresponding digital output/relay must be set to accept data from the sequencer: P140, P142, P441 = 27 |
| Value set in P748        | 0                                      | 1                 | 2  | 3               | 4  | 5 | 6 | 7 |   |   |   |   |   |              |   |   |   |   |   |   |   |   |             |   |   |   |   |   |   |   |   |                          |   |   |   |   |   |   |   |   |   |
| Relay (BR 0)             | 0                                      | 1                 | 0  | 1               | 0  | 1 | 0 | 1 |   |   |   |   |   |              |   |   |   |   |   |   |   |   |             |   |   |   |   |   |   |   |   |                          |   |   |   |   |   |   |   |   |   |
| TB14 (BR 1)              | 0                                      | 0                 | 1  | 1               | 0  | 0 | 1 | 1 |   |   |   |   |   |              |   |   |   |   |   |   |   |   |             |   |   |   |   |   |   |   |   |                          |   |   |   |   |   |   |   |   |   |
| I/O option Relay (Bit 2) | 0                                      | 0                 | 0  | 0               | 1  | 1 | 1 | 1 |   |   |   |   |   |              |   |   |   |   |   |   |   |   |             |   |   |   |   |   |   |   |   |                          |   |   |   |   |   |   |   |   |   |
| P749                     | Segment #8 TB30<br>Analog Output Value | 0.00              | 0.00 (VDC)   | 10.00           | TB30 configuration parameter must be set to accept this value: P150 = 10 |   |   |   |   |   |   |   |   |              |   |   |   |   |   |   |   |   |             |   |   |   |   |   |   |   |   |                          |   |   |   |   |   |   |   |   |   |

## Commissioning



| Code                     |   | Possible Settings |   |                  |                 | IMPORTANT  |   |   |   |   |   |   |   |   |               |   |   |   |   |   |   |   |   |              |   |   |   |   |   |   |   |   |                          |   |   |   |   |   |   |   |   |   |
|--------------------------|---|-------------------|---|------------------|-----------------|--|---|---|---|---|---|---|---|---|---------------|---|---|---|---|---|---|---|---|--------------|---|---|---|---|---|---|---|---|--------------------------|---|---|---|---|---|---|---|---|---|
| No.                      | Name                                    | Default           | Selection   |                  |                 |  |   |   |   |   |   |   |   |   |               |   |   |   |   |   |   |   |   |              |   |   |   |   |   |   |   |   |                          |   |   |   |   |   |   |   |   |   |
| <b>Segment #9</b>        |   |                   |   |                  |                 |  |   |   |   |   |   |   |   |   |               |   |   |   |   |   |   |   |   |              |   |   |   |   |   |   |   |   |                          |   |   |   |   |   |   |   |   |   |
| P750                     | Segment #9<br>Frequency Setpoint        | 0.0               | -500.0  | {Hz}             | 500.0           | If P112 = 1, negative sign forces reverse direction                      |   |   |   |   |   |   |   |   |               |   |   |   |   |   |   |   |   |              |   |   |   |   |   |   |   |   |                          |   |   |   |   |   |   |   |   |   |
| P751                     | Segment #9<br>Accel/Decel Time          | 20.0              | 0.0   | {sec}            | 3600.0          |  |   |   |   |   |   |   |   |   |               |   |   |   |   |   |   |   |   |              |   |   |   |   |   |   |   |   |                          |   |   |   |   |   |   |   |   |   |
| P752                     | Segment #9<br>Time in current step      | 0.0<br>0          | 0.0<br>0  | (P708)<br>(P708) | 6553.5<br>65535 | Scaling/units depend on P708<br>Skip segment if time = 0                 |   |   |   |   |   |   |   |   |               |   |   |   |   |   |   |   |   |              |   |   |   |   |   |   |   |   |                          |   |   |   |   |   |   |   |   |   |
| P753                     | Segment #9<br>Digital Output State      | 0                 | <table border="1" style="font-size: small;"> <tr> <td>Value set in P753</td> <td>0</td><td>1</td><td>2</td><td>3</td><td>4</td><td>5</td><td>6</td><td>7</td> </tr> <tr> <td>Relay (Bit 0)</td> <td>0</td><td>1</td><td>0</td><td>1</td><td>0</td><td>1</td><td>0</td><td>1</td> </tr> <tr> <td>TB14 (Bit 1)</td> <td>0</td><td>0</td><td>1</td><td>1</td><td>0</td><td>0</td><td>1</td><td>1</td> </tr> <tr> <td>I/O option Relay (Bit 2)</td> <td>0</td><td>0</td><td>0</td><td>0</td><td>1</td><td>1</td><td>1</td><td>1</td> </tr> </table> |                  |                 | Value set in P753  | 0 | 1 | 2 | 3 | 4 | 5 | 6 | 7 | Relay (Bit 0) | 0 | 1 | 0 | 1 | 0 | 1 | 0 | 1 | TB14 (Bit 1) | 0 | 0 | 1 | 1 | 0 | 0 | 1 | 1 | I/O option Relay (Bit 2) | 0 | 0 | 0 | 0 | 1 | 1 | 1 | 1 | bit = 0: OFF (De-energized)<br>bit = 1: ON (Energized)<br>The corresponding digital output/relay must be set to accept data from the sequencer: P140, P142, P441 = 27 |
| Value set in P753        | 0                                       | 1                 | 2   | 3                | 4               | 5  | 6 | 7 |   |   |   |   |   |   |               |   |   |   |   |   |   |   |   |              |   |   |   |   |   |   |   |   |                          |   |   |   |   |   |   |   |   |   |
| Relay (Bit 0)            | 0                                       | 1                 | 0   | 1                | 0               | 1  | 0 | 1 |   |   |   |   |   |   |               |   |   |   |   |   |   |   |   |              |   |   |   |   |   |   |   |   |                          |   |   |   |   |   |   |   |   |   |
| TB14 (Bit 1)             | 0                                       | 0                 | 1   | 1                | 0               | 0  | 1 | 1 |   |   |   |   |   |   |               |   |   |   |   |   |   |   |   |              |   |   |   |   |   |   |   |   |                          |   |   |   |   |   |   |   |   |   |
| I/O option Relay (Bit 2) | 0                                       | 0                 | 0   | 0                | 1               | 1  | 1 | 1 |   |   |   |   |   |   |               |   |   |   |   |   |   |   |   |              |   |   |   |   |   |   |   |   |                          |   |   |   |   |   |   |   |   |   |
| P754                     | Segment #9 TB30<br>Analog Output Value  | 0.00              | 0.00  | {VDC}            | 10.00           | TB30 configuration parameter must be set to accept this value: P150 = 10 |   |   |   |   |   |   |   |   |               |   |   |   |   |   |   |   |   |              |   |   |   |   |   |   |   |   |                          |   |   |   |   |   |   |   |   |   |
| <b>Segment #10</b>       |   |                   |   |                  |                 |  |   |   |   |   |   |   |   |   |               |   |   |   |   |   |   |   |   |              |   |   |   |   |   |   |   |   |                          |   |   |   |   |   |   |   |   |   |
| P755                     | Segment #10<br>Frequency Setpoint       | 0.0               | -500.0  | {Hz}             | 500.0           | If P112 = 1, negative sign forces reverse direction                      |   |   |   |   |   |   |   |   |               |   |   |   |   |   |   |   |   |              |   |   |   |   |   |   |   |   |                          |   |   |   |   |   |   |   |   |   |
| P756                     | Segment #10<br>Accel/Decel Time         | 20.0              | 0.0   | {sec}            | 3600.0          |  |   |   |   |   |   |   |   |   |               |   |   |   |   |   |   |   |   |              |   |   |   |   |   |   |   |   |                          |   |   |   |   |   |   |   |   |   |
| P757                     | Segment #10<br>Time in current step     | 0.0<br>0          | 0.0<br>0  | (P708)<br>(P708) | 6553.5<br>65535 | Scaling/units depend on P708<br>Skip segment if time = 0                 |   |   |   |   |   |   |   |   |               |   |   |   |   |   |   |   |   |              |   |   |   |   |   |   |   |   |                          |   |   |   |   |   |   |   |   |   |
| P758                     | Segment #10<br>Digital Output State     | 0                 | <table border="1" style="font-size: small;"> <tr> <td>Value set in P758</td> <td>0</td><td>1</td><td>2</td><td>3</td><td>4</td><td>5</td><td>6</td><td>7</td> </tr> <tr> <td>Relay (Bit 0)</td> <td>0</td><td>1</td><td>0</td><td>1</td><td>0</td><td>1</td><td>0</td><td>1</td> </tr> <tr> <td>TB14 (Bit 1)</td> <td>0</td><td>0</td><td>1</td><td>1</td><td>0</td><td>0</td><td>1</td><td>1</td> </tr> <tr> <td>I/O option Relay (Bit 2)</td> <td>0</td><td>0</td><td>0</td><td>0</td><td>1</td><td>1</td><td>1</td><td>1</td> </tr> </table> |                  |                 | Value set in P758  | 0 | 1 | 2 | 3 | 4 | 5 | 6 | 7 | Relay (Bit 0) | 0 | 1 | 0 | 1 | 0 | 1 | 0 | 1 | TB14 (Bit 1) | 0 | 0 | 1 | 1 | 0 | 0 | 1 | 1 | I/O option Relay (Bit 2) | 0 | 0 | 0 | 0 | 1 | 1 | 1 | 1 | bit = 0: OFF (De-energized)<br>bit = 1: ON (Energized)<br>The corresponding digital output/relay must be set to accept data from the sequencer: P140, P142, P441 = 27 |
| Value set in P758        | 0                                       | 1                 | 2   | 3                | 4               | 5  | 6 | 7 |   |   |   |   |   |   |               |   |   |   |   |   |   |   |   |              |   |   |   |   |   |   |   |   |                          |   |   |   |   |   |   |   |   |   |
| Relay (Bit 0)            | 0                                       | 1                 | 0   | 1                | 0               | 1  | 0 | 1 |   |   |   |   |   |   |               |   |   |   |   |   |   |   |   |              |   |   |   |   |   |   |   |   |                          |   |   |   |   |   |   |   |   |   |
| TB14 (Bit 1)             | 0                                       | 0                 | 1   | 1                | 0               | 0  | 1 | 1 |   |   |   |   |   |   |               |   |   |   |   |   |   |   |   |              |   |   |   |   |   |   |   |   |                          |   |   |   |   |   |   |   |   |   |
| I/O option Relay (Bit 2) | 0                                       | 0                 | 0   | 0                | 1               | 1  | 1 | 1 |   |   |   |   |   |   |               |   |   |   |   |   |   |   |   |              |   |   |   |   |   |   |   |   |                          |   |   |   |   |   |   |   |   |   |
| P759                     | Segment #10 TB30<br>Analog Output Value | 0.00              | 0.00  | {VDC}            | 10.00           | TB30 configuration parameter must be set to accept this value: P150 = 10 |   |   |   |   |   |   |   |   |               |   |   |   |   |   |   |   |   |              |   |   |   |   |   |   |   |   |                          |   |   |   |   |   |   |   |   |   |
| <b>Segment #11</b>       |   |                   |   |                  |                 |  |   |   |   |   |   |   |   |   |               |   |   |   |   |   |   |   |   |              |   |   |   |   |   |   |   |   |                          |   |   |   |   |   |   |   |   |   |
| P760                     | Segment #11<br>Frequency Setpoint       | 0.0               | -500.0  | {Hz}             | 500.0           | If P112 = 1, negative sign forces reverse direction                      |   |   |   |   |   |   |   |   |               |   |   |   |   |   |   |   |   |              |   |   |   |   |   |   |   |   |                          |   |   |   |   |   |   |   |   |   |
| P761                     | Segment #11<br>Accel/Decel Time         | 20.0              | 0.0   | {sec}            | 3600.0          |  |   |   |   |   |   |   |   |   |               |   |   |   |   |   |   |   |   |              |   |   |   |   |   |   |   |   |                          |   |   |   |   |   |   |   |   |   |
| P762                     | Segment #11<br>Time in current step     | 0.0<br>0          | 0.0<br>0  | (P708)<br>(P708) | 6553.5<br>65535 | Scaling/units depend on P708<br>Skip segment if time = 0                 |   |   |   |   |   |   |   |   |               |   |   |   |   |   |   |   |   |              |   |   |   |   |   |   |   |   |                          |   |   |   |   |   |   |   |   |   |
| P763                     | Segment #11<br>Digital Output State     | 0                 | <table border="1" style="font-size: small;"> <tr> <td>Value set in P763</td> <td>0</td><td>1</td><td>2</td><td>3</td><td>4</td><td>5</td><td>6</td><td>7</td> </tr> <tr> <td>Relay (Bit 0)</td> <td>0</td><td>1</td><td>0</td><td>1</td><td>0</td><td>1</td><td>0</td><td>1</td> </tr> <tr> <td>TB14 (Bit 1)</td> <td>0</td><td>0</td><td>1</td><td>1</td><td>0</td><td>0</td><td>1</td><td>1</td> </tr> <tr> <td>I/O option Relay (Bit 2)</td> <td>0</td><td>0</td><td>0</td><td>0</td><td>1</td><td>1</td><td>1</td><td>1</td> </tr> </table> |                  |                 | Value set in P763  | 0 | 1 | 2 | 3 | 4 | 5 | 6 | 7 | Relay (Bit 0) | 0 | 1 | 0 | 1 | 0 | 1 | 0 | 1 | TB14 (Bit 1) | 0 | 0 | 1 | 1 | 0 | 0 | 1 | 1 | I/O option Relay (Bit 2) | 0 | 0 | 0 | 0 | 1 | 1 | 1 | 1 | bit = 0: OFF (De-energized)<br>bit = 1: ON (Energized)<br>The corresponding digital output/relay must be set to accept data from the sequencer: P140, P142, P441 = 27 |
| Value set in P763        | 0                                       | 1                 | 2   | 3                | 4               | 5  | 6 | 7 |   |   |   |   |   |   |               |   |   |   |   |   |   |   |   |              |   |   |   |   |   |   |   |   |                          |   |   |   |   |   |   |   |   |   |
| Relay (Bit 0)            | 0                                       | 1                 | 0   | 1                | 0               | 1  | 0 | 1 |   |   |   |   |   |   |               |   |   |   |   |   |   |   |   |              |   |   |   |   |   |   |   |   |                          |   |   |   |   |   |   |   |   |   |
| TB14 (Bit 1)             | 0                                       | 0                 | 1   | 1                | 0               | 0  | 1 | 1 |   |   |   |   |   |   |               |   |   |   |   |   |   |   |   |              |   |   |   |   |   |   |   |   |                          |   |   |   |   |   |   |   |   |   |
| I/O option Relay (Bit 2) | 0                                       | 0                 | 0   | 0                | 1               | 1  | 1 | 1 |   |   |   |   |   |   |               |   |   |   |   |   |   |   |   |              |   |   |   |   |   |   |   |   |                          |   |   |   |   |   |   |   |   |   |
| P764                     | Segment #11 TB30<br>Analog Output Value | 0.00              | 0.00  | {VDC}            | 10.00           | TB30 configuration parameter must be set to accept this value: P150 = 10 |   |   |   |   |   |   |   |   |               |   |   |   |   |   |   |   |   |              |   |   |   |   |   |   |   |   |                          |   |   |   |   |   |   |   |   |   |



## Commissioning

| Code                     |   | Possible Settings |   |                               | IMPORTANT  |   |   |   |   |   |   |   |   |               |   |   |   |   |   |   |   |   |              |   |   |   |   |   |   |   |   |                          |   |   |   |   |   |   |   |   |   |
|--------------------------|---|-------------------|---|-------------------------------|--|---|---|---|---|---|---|---|---|---------------|---|---|---|---|---|---|---|---|--------------|---|---|---|---|---|---|---|---|--------------------------|---|---|---|---|---|---|---|---|---|
| No.                      | Name                                    | Default           | Selection   |                               |  |   |   |   |   |   |   |   |   |               |   |   |   |   |   |   |   |   |              |   |   |   |   |   |   |   |   |                          |   |   |   |   |   |   |   |   |   |
| <b>Segment #12</b>       |   |                   |   |                               |  |   |   |   |   |   |   |   |   |               |   |   |   |   |   |   |   |   |              |   |   |   |   |   |   |   |   |                          |   |   |   |   |   |   |   |   |   |
| P765                     | Segment #12<br>Frequency Setpoint       | 0.0               | -500.0  | {Hz} 500.0                    | If P112 = 1, negative sign forces reverse direction                      |   |   |   |   |   |   |   |   |               |   |   |   |   |   |   |   |   |              |   |   |   |   |   |   |   |   |                          |   |   |   |   |   |   |   |   |   |
| P766                     | Segment #12<br>Accel/Decel Time         | 20.0              | 0.0   | {sec} 3600.0                  |  |   |   |   |   |   |   |   |   |               |   |   |   |   |   |   |   |   |              |   |   |   |   |   |   |   |   |                          |   |   |   |   |   |   |   |   |   |
| P767                     | Segment #12<br>Time in current step     | 0.0<br>0          | 0.0<br>0  | {P708} 6553.5<br>{P708} 65535 | Scaling/units depend on P708<br>Skip segment if time = 0                 |   |   |   |   |   |   |   |   |               |   |   |   |   |   |   |   |   |              |   |   |   |   |   |   |   |   |                          |   |   |   |   |   |   |   |   |   |
| P768                     | Segment #12<br>Digital Output State     | 0                 | <table border="1" style="font-size: small;"> <tr> <td>Value set in P768</td> <td>0</td><td>1</td><td>2</td><td>3</td><td>4</td><td>5</td><td>6</td><td>7</td> </tr> <tr> <td>Relay (Bit 0)</td> <td>0</td><td>1</td><td>0</td><td>1</td><td>0</td><td>1</td><td>0</td><td>1</td> </tr> <tr> <td>TB14 (Bit 1)</td> <td>0</td><td>0</td><td>1</td><td>1</td><td>0</td><td>0</td><td>1</td><td>1</td> </tr> <tr> <td>I/O option Relay (Bit 2)</td> <td>0</td><td>0</td><td>0</td><td>0</td><td>1</td><td>1</td><td>1</td><td>1</td> </tr> </table> |                               | Value set in P768  | 0 | 1 | 2 | 3 | 4 | 5 | 6 | 7 | Relay (Bit 0) | 0 | 1 | 0 | 1 | 0 | 1 | 0 | 1 | TB14 (Bit 1) | 0 | 0 | 1 | 1 | 0 | 0 | 1 | 1 | I/O option Relay (Bit 2) | 0 | 0 | 0 | 0 | 1 | 1 | 1 | 1 | bit = 0: OFF (De-energized)<br>bit = 1: ON (Energized)<br>The corresponding digital output/relay must be set to accept data from the sequencer: P140, P142, P441 = 27 |
| Value set in P768        | 0                                       | 1                 | 2   | 3                             | 4  | 5 | 6 | 7 |   |   |   |   |   |               |   |   |   |   |   |   |   |   |              |   |   |   |   |   |   |   |   |                          |   |   |   |   |   |   |   |   |   |
| Relay (Bit 0)            | 0                                       | 1                 | 0   | 1                             | 0  | 1 | 0 | 1 |   |   |   |   |   |               |   |   |   |   |   |   |   |   |              |   |   |   |   |   |   |   |   |                          |   |   |   |   |   |   |   |   |   |
| TB14 (Bit 1)             | 0                                       | 0                 | 1   | 1                             | 0  | 0 | 1 | 1 |   |   |   |   |   |               |   |   |   |   |   |   |   |   |              |   |   |   |   |   |   |   |   |                          |   |   |   |   |   |   |   |   |   |
| I/O option Relay (Bit 2) | 0                                       | 0                 | 0   | 0                             | 1  | 1 | 1 | 1 |   |   |   |   |   |               |   |   |   |   |   |   |   |   |              |   |   |   |   |   |   |   |   |                          |   |   |   |   |   |   |   |   |   |
| P769                     | Segment #12 TB30<br>Analog Output Value | 0.00              | 0.00  | {VDC} 10.00                   | TB30 configuration parameter must be set to accept this value: P150 = 10 |   |   |   |   |   |   |   |   |               |   |   |   |   |   |   |   |   |              |   |   |   |   |   |   |   |   |                          |   |   |   |   |   |   |   |   |   |
| <b>Segment #13</b>       |   |                   |   |                               |  |   |   |   |   |   |   |   |   |               |   |   |   |   |   |   |   |   |              |   |   |   |   |   |   |   |   |                          |   |   |   |   |   |   |   |   |   |
| P770                     | Segment #13<br>Frequency Setpoint       | 0.0               | -500.0  | {Hz} 500.0                    | If P112 = 1, negative sign forces reverse direction                      |   |   |   |   |   |   |   |   |               |   |   |   |   |   |   |   |   |              |   |   |   |   |   |   |   |   |                          |   |   |   |   |   |   |   |   |   |
| P771                     | Segment #13<br>Accel/Decel Time         | 20.0              | 0.0   | {sec} 3600.0                  |  |   |   |   |   |   |   |   |   |               |   |   |   |   |   |   |   |   |              |   |   |   |   |   |   |   |   |                          |   |   |   |   |   |   |   |   |   |
| P772                     | Segment #13<br>Time in current step     | 0.0<br>0          | 0.0<br>0  | {P708} 6553.5<br>{P708} 65535 | Scaling/units depend on P708<br>Skip segment if time = 0                 |   |   |   |   |   |   |   |   |               |   |   |   |   |   |   |   |   |              |   |   |   |   |   |   |   |   |                          |   |   |   |   |   |   |   |   |   |
| P773                     | Segment #13<br>Digital Output State     | 0                 | <table border="1" style="font-size: small;"> <tr> <td>Value set in P773</td> <td>0</td><td>1</td><td>2</td><td>3</td><td>4</td><td>5</td><td>6</td><td>7</td> </tr> <tr> <td>Relay (Bit 0)</td> <td>0</td><td>1</td><td>0</td><td>1</td><td>0</td><td>1</td><td>0</td><td>1</td> </tr> <tr> <td>TB14 (Bit 1)</td> <td>0</td><td>0</td><td>1</td><td>1</td><td>0</td><td>0</td><td>1</td><td>1</td> </tr> <tr> <td>I/O option Relay (Bit 2)</td> <td>0</td><td>0</td><td>0</td><td>0</td><td>1</td><td>1</td><td>1</td><td>1</td> </tr> </table> |                               | Value set in P773  | 0 | 1 | 2 | 3 | 4 | 5 | 6 | 7 | Relay (Bit 0) | 0 | 1 | 0 | 1 | 0 | 1 | 0 | 1 | TB14 (Bit 1) | 0 | 0 | 1 | 1 | 0 | 0 | 1 | 1 | I/O option Relay (Bit 2) | 0 | 0 | 0 | 0 | 1 | 1 | 1 | 1 | bit = 0: OFF (De-energized)<br>bit = 1: ON (Energized)<br>The corresponding digital output/relay must be set to accept data from the sequencer: P140, P142, P441 = 27 |
| Value set in P773        | 0                                       | 1                 | 2   | 3                             | 4  | 5 | 6 | 7 |   |   |   |   |   |               |   |   |   |   |   |   |   |   |              |   |   |   |   |   |   |   |   |                          |   |   |   |   |   |   |   |   |   |
| Relay (Bit 0)            | 0                                       | 1                 | 0   | 1                             | 0  | 1 | 0 | 1 |   |   |   |   |   |               |   |   |   |   |   |   |   |   |              |   |   |   |   |   |   |   |   |                          |   |   |   |   |   |   |   |   |   |
| TB14 (Bit 1)             | 0                                       | 0                 | 1   | 1                             | 0  | 0 | 1 | 1 |   |   |   |   |   |               |   |   |   |   |   |   |   |   |              |   |   |   |   |   |   |   |   |                          |   |   |   |   |   |   |   |   |   |
| I/O option Relay (Bit 2) | 0                                       | 0                 | 0   | 0                             | 1  | 1 | 1 | 1 |   |   |   |   |   |               |   |   |   |   |   |   |   |   |              |   |   |   |   |   |   |   |   |                          |   |   |   |   |   |   |   |   |   |
| P774                     | Segment #13 TB30<br>Analog Output Value | 0.00              | 0.00  | {VDC} 10.00                   | TB30 configuration parameter must be set to accept this value: P150 = 10 |   |   |   |   |   |   |   |   |               |   |   |   |   |   |   |   |   |              |   |   |   |   |   |   |   |   |                          |   |   |   |   |   |   |   |   |   |
| <b>Segment #14</b>       |   |                   |   |                               |  |   |   |   |   |   |   |   |   |               |   |   |   |   |   |   |   |   |              |   |   |   |   |   |   |   |   |                          |   |   |   |   |   |   |   |   |   |
| P775                     | Segment #14<br>Frequency Setpoint       | 0.0               | -500.0  | {Hz} 500.0                    | If P112 = 1, negative sign forces reverse direction                      |   |   |   |   |   |   |   |   |               |   |   |   |   |   |   |   |   |              |   |   |   |   |   |   |   |   |                          |   |   |   |   |   |   |   |   |   |
| P776                     | Segment #14<br>Accel/Decel Time         | 20.0              | 0.0   | {sec} 3600.0                  |  |   |   |   |   |   |   |   |   |               |   |   |   |   |   |   |   |   |              |   |   |   |   |   |   |   |   |                          |   |   |   |   |   |   |   |   |   |
| P777                     | Segment #14<br>Time in current step     | 0.0<br>0          | 0.0<br>0  | {P708} 6553.5<br>{P708} 65535 | Scaling/units depend on P708<br>Skip segment if time = 0                 |   |   |   |   |   |   |   |   |               |   |   |   |   |   |   |   |   |              |   |   |   |   |   |   |   |   |                          |   |   |   |   |   |   |   |   |   |
| P778                     | Segment #14<br>Digital Output State     | 0                 | <table border="1" style="font-size: small;"> <tr> <td>Value set in P778</td> <td>0</td><td>1</td><td>2</td><td>3</td><td>4</td><td>5</td><td>6</td><td>7</td> </tr> <tr> <td>Relay (Bit 0)</td> <td>0</td><td>1</td><td>0</td><td>1</td><td>0</td><td>1</td><td>0</td><td>1</td> </tr> <tr> <td>TB14 (Bit 1)</td> <td>0</td><td>0</td><td>1</td><td>1</td><td>0</td><td>0</td><td>1</td><td>1</td> </tr> <tr> <td>I/O option Relay (Bit 2)</td> <td>0</td><td>0</td><td>0</td><td>0</td><td>1</td><td>1</td><td>1</td><td>1</td> </tr> </table> |                               | Value set in P778  | 0 | 1 | 2 | 3 | 4 | 5 | 6 | 7 | Relay (Bit 0) | 0 | 1 | 0 | 1 | 0 | 1 | 0 | 1 | TB14 (Bit 1) | 0 | 0 | 1 | 1 | 0 | 0 | 1 | 1 | I/O option Relay (Bit 2) | 0 | 0 | 0 | 0 | 1 | 1 | 1 | 1 | bit = 0: OFF (De-energized)<br>bit = 1: ON (Energized)<br>The corresponding digital output/relay must be set to accept data from the sequencer: P140, P142, P441 = 27 |
| Value set in P778        | 0                                       | 1                 | 2   | 3                             | 4  | 5 | 6 | 7 |   |   |   |   |   |               |   |   |   |   |   |   |   |   |              |   |   |   |   |   |   |   |   |                          |   |   |   |   |   |   |   |   |   |
| Relay (Bit 0)            | 0                                       | 1                 | 0   | 1                             | 0  | 1 | 0 | 1 |   |   |   |   |   |               |   |   |   |   |   |   |   |   |              |   |   |   |   |   |   |   |   |                          |   |   |   |   |   |   |   |   |   |
| TB14 (Bit 1)             | 0                                       | 0                 | 1   | 1                             | 0  | 0 | 1 | 1 |   |   |   |   |   |               |   |   |   |   |   |   |   |   |              |   |   |   |   |   |   |   |   |                          |   |   |   |   |   |   |   |   |   |
| I/O option Relay (Bit 2) | 0                                       | 0                 | 0   | 0                             | 1  | 1 | 1 | 1 |   |   |   |   |   |               |   |   |   |   |   |   |   |   |              |   |   |   |   |   |   |   |   |                          |   |   |   |   |   |   |   |   |   |
| P779                     | Segment #14 TB30<br>Analog Output Value | 0.00              | 0.00  | {VDC} 10.00                   | TB30 configuration parameter must be set to accept this value: P150 = 10 |   |   |   |   |   |   |   |   |               |   |   |   |   |   |   |   |   |              |   |   |   |   |   |   |   |   |                          |   |   |   |   |   |   |   |   |   |

## Commissioning



| Code                     |  | Possible Settings |   |                  |                 | IMPORTANT  |   |   |   |   |   |   |   |   |               |   |   |   |   |   |   |   |   |              |   |   |   |   |   |   |   |   |                          |   |   |   |   |   |   |   |   |   |
|--------------------------|--|-------------------|---|------------------|-----------------|--|---|---|---|---|---|---|---|---|---------------|---|---|---|---|---|---|---|---|--------------|---|---|---|---|---|---|---|---|--------------------------|---|---|---|---|---|---|---|---|---|
| No.                      | Name   | Default           | Selection   |                  |                 |  |   |   |   |   |   |   |   |   |               |   |   |   |   |   |   |   |   |              |   |   |   |   |   |   |   |   |                          |   |   |   |   |   |   |   |   |   |
| <b>Segment #15</b>       |  |                   |   |                  |                 |  |   |   |   |   |   |   |   |   |               |   |   |   |   |   |   |   |   |              |   |   |   |   |   |   |   |   |                          |   |   |   |   |   |   |   |   |   |
| P780                     | Segment #15 Frequency Setpoint                       | 0.0               | -500.0  | (Hz)             | 500.0           | If P112 = 1, negative sign forces reverse direction                      |   |   |   |   |   |   |   |   |               |   |   |   |   |   |   |   |   |              |   |   |   |   |   |   |   |   |                          |   |   |   |   |   |   |   |   |   |
| P781                     | Segment #15 Accel/Decel Time                         | 20.0              | 0.0   | (sec)            | 3600.0          |  |   |   |   |   |   |   |   |   |               |   |   |   |   |   |   |   |   |              |   |   |   |   |   |   |   |   |                          |   |   |   |   |   |   |   |   |   |
| P782                     | Segment #15 Time in current step                     | 0.0<br>0          | 0.0<br>0  | (P708)<br>(P708) | 6553.5<br>65535 | Scaling/units depend on P708<br>Skip segment if time = 0                 |   |   |   |   |   |   |   |   |               |   |   |   |   |   |   |   |   |              |   |   |   |   |   |   |   |   |                          |   |   |   |   |   |   |   |   |   |
| P783                     | Segment #15 Digital Output State                     | 0                 | <table border="1" style="font-size: small;"> <tr><td>Value set in P783</td><td>0</td><td>1</td><td>2</td><td>3</td><td>4</td><td>5</td><td>6</td><td>7</td></tr> <tr><td>Relay (Bit 0)</td><td>0</td><td>1</td><td>0</td><td>1</td><td>0</td><td>1</td><td>0</td><td>1</td></tr> <tr><td>TB14 (Bit 1)</td><td>0</td><td>0</td><td>1</td><td>1</td><td>0</td><td>0</td><td>1</td><td>1</td></tr> <tr><td>I/O option Relay (Bit 2)</td><td>0</td><td>0</td><td>0</td><td>0</td><td>1</td><td>1</td><td>1</td><td>1</td></tr> </table> |                  |                 | Value set in P783  | 0 | 1 | 2 | 3 | 4 | 5 | 6 | 7 | Relay (Bit 0) | 0 | 1 | 0 | 1 | 0 | 1 | 0 | 1 | TB14 (Bit 1) | 0 | 0 | 1 | 1 | 0 | 0 | 1 | 1 | I/O option Relay (Bit 2) | 0 | 0 | 0 | 0 | 1 | 1 | 1 | 1 | bit = 0: OFF (De-energized)<br>bit = 1: ON (Energized)<br>The corresponding digital output/relay must be set to accept data from the sequencer: P140, P142, P441 = 27 |
| Value set in P783        | 0  | 1                 | 2   | 3                | 4               | 5  | 6 | 7 |   |   |   |   |   |   |               |   |   |   |   |   |   |   |   |              |   |   |   |   |   |   |   |   |                          |   |   |   |   |   |   |   |   |   |
| Relay (Bit 0)            | 0  | 1                 | 0   | 1                | 0               | 1  | 0 | 1 |   |   |   |   |   |   |               |   |   |   |   |   |   |   |   |              |   |   |   |   |   |   |   |   |                          |   |   |   |   |   |   |   |   |   |
| TB14 (Bit 1)             | 0  | 0                 | 1   | 1                | 0               | 0  | 1 | 1 |   |   |   |   |   |   |               |   |   |   |   |   |   |   |   |              |   |   |   |   |   |   |   |   |                          |   |   |   |   |   |   |   |   |   |
| I/O option Relay (Bit 2) | 0  | 0                 | 0   | 0                | 1               | 1  | 1 | 1 |   |   |   |   |   |   |               |   |   |   |   |   |   |   |   |              |   |   |   |   |   |   |   |   |                          |   |   |   |   |   |   |   |   |   |
| P784                     | Segment #15 TB30 Analog Output Value                 | 0.00              | 0.00  | (VDC)            | 10.00           | TB30 configuration parameter must be set to accept this value: P150 = 10 |   |   |   |   |   |   |   |   |               |   |   |   |   |   |   |   |   |              |   |   |   |   |   |   |   |   |                          |   |   |   |   |   |   |   |   |   |
| <b>Segment #16</b>       |  |                   |   |                  |                 |  |   |   |   |   |   |   |   |   |               |   |   |   |   |   |   |   |   |              |   |   |   |   |   |   |   |   |                          |   |   |   |   |   |   |   |   |   |
| P785                     | Segment #16 Frequency Setpoint                       | 0.0               | -500.0  | (Hz)             | 500.0           | If P112 = 1, negative sign forces reverse direction                      |   |   |   |   |   |   |   |   |               |   |   |   |   |   |   |   |   |              |   |   |   |   |   |   |   |   |                          |   |   |   |   |   |   |   |   |   |
| P786                     | Segment #16 Accel/Decel Time                         | 20.0              | 0.0   | (sec)            | 3600.0          |  |   |   |   |   |   |   |   |   |               |   |   |   |   |   |   |   |   |              |   |   |   |   |   |   |   |   |                          |   |   |   |   |   |   |   |   |   |
| P787                     | Segment #16 Time in current step                     | 0.0<br>0          | 0.0<br>0  | (P708)<br>(P708) | 6553.5<br>65535 | Scaling/units depend on P708<br>Skip segment if time = 0                 |   |   |   |   |   |   |   |   |               |   |   |   |   |   |   |   |   |              |   |   |   |   |   |   |   |   |                          |   |   |   |   |   |   |   |   |   |
| P788                     | Segment #16 Digital Output State                     | 0                 | <table border="1" style="font-size: small;"> <tr><td>Value set in P788</td><td>0</td><td>1</td><td>2</td><td>3</td><td>4</td><td>5</td><td>6</td><td>7</td></tr> <tr><td>Relay (Bit 0)</td><td>0</td><td>1</td><td>0</td><td>1</td><td>0</td><td>1</td><td>0</td><td>1</td></tr> <tr><td>TB14 (Bit 1)</td><td>0</td><td>0</td><td>1</td><td>1</td><td>0</td><td>0</td><td>1</td><td>1</td></tr> <tr><td>I/O option Relay (Bit 2)</td><td>0</td><td>0</td><td>0</td><td>0</td><td>1</td><td>1</td><td>1</td><td>1</td></tr> </table> |                  |                 | Value set in P788  | 0 | 1 | 2 | 3 | 4 | 5 | 6 | 7 | Relay (Bit 0) | 0 | 1 | 0 | 1 | 0 | 1 | 0 | 1 | TB14 (Bit 1) | 0 | 0 | 1 | 1 | 0 | 0 | 1 | 1 | I/O option Relay (Bit 2) | 0 | 0 | 0 | 0 | 1 | 1 | 1 | 1 | bit = 0: OFF (De-energized)<br>bit = 1: ON (Energized)<br>The corresponding digital output/relay must be set to accept data from the sequencer: P140, P142, P441 = 27 |
| Value set in P788        | 0  | 1                 | 2   | 3                | 4               | 5  | 6 | 7 |   |   |   |   |   |   |               |   |   |   |   |   |   |   |   |              |   |   |   |   |   |   |   |   |                          |   |   |   |   |   |   |   |   |   |
| Relay (Bit 0)            | 0  | 1                 | 0   | 1                | 0               | 1  | 0 | 1 |   |   |   |   |   |   |               |   |   |   |   |   |   |   |   |              |   |   |   |   |   |   |   |   |                          |   |   |   |   |   |   |   |   |   |
| TB14 (Bit 1)             | 0  | 0                 | 1   | 1                | 0               | 0  | 1 | 1 |   |   |   |   |   |   |               |   |   |   |   |   |   |   |   |              |   |   |   |   |   |   |   |   |                          |   |   |   |   |   |   |   |   |   |
| I/O option Relay (Bit 2) | 0  | 0                 | 0   | 0                | 1               | 1  | 1 | 1 |   |   |   |   |   |   |               |   |   |   |   |   |   |   |   |              |   |   |   |   |   |   |   |   |                          |   |   |   |   |   |   |   |   |   |
| P789                     | Segment #16 TB30 Analog Output Value                 | 0.00              | 0.00  | (VDC)            | 10.00           | TB30 configuration parameter must be set to accept this value: P150 = 10 |   |   |   |   |   |   |   |   |               |   |   |   |   |   |   |   |   |              |   |   |   |   |   |   |   |   |                          |   |   |   |   |   |   |   |   |   |
| <b>End Segment</b>       |  |                   |   |                  |                 |  |   |   |   |   |   |   |   |   |               |   |   |   |   |   |   |   |   |              |   |   |   |   |   |   |   |   |                          |   |   |   |   |   |   |   |   |   |
| P790                     | End Segment: Frequency Setpoint                      | 0.0               | -500.0  | (Hz)             | 500.0           | If P112 = 1, negative sign forces reverse direction                      |   |   |   |   |   |   |   |   |               |   |   |   |   |   |   |   |   |              |   |   |   |   |   |   |   |   |                          |   |   |   |   |   |   |   |   |   |
| P791                     | End Segment: Accel/Decel Time                        | 5.0               | 0.0   | (sec)            | 3600.0          |  |   |   |   |   |   |   |   |   |               |   |   |   |   |   |   |   |   |              |   |   |   |   |   |   |   |   |                          |   |   |   |   |   |   |   |   |   |
| P792                     | End Segment: Delay before P793, 794 & 795 activation | 0.0<br>0          | 0.0<br>0  | (P708)<br>(P708) | 6553.5<br>65535 | Scaling/units depend on P708   |   |   |   |   |   |   |   |   |               |   |   |   |   |   |   |   |   |              |   |   |   |   |   |   |   |   |                          |   |   |   |   |   |   |   |   |   |
| P793                     | End Segment: Digital Output State                    |                   | <table border="1" style="font-size: small;"> <tr><td>Value set in P793</td><td>0</td><td>1</td><td>2</td><td>3</td><td>4</td><td>5</td><td>6</td><td>7</td></tr> <tr><td>Relay (Bit 0)</td><td>0</td><td>1</td><td>0</td><td>1</td><td>0</td><td>1</td><td>0</td><td>1</td></tr> <tr><td>TB14 (Bit 1)</td><td>0</td><td>0</td><td>1</td><td>1</td><td>0</td><td>0</td><td>1</td><td>1</td></tr> <tr><td>I/O option Relay (Bit 2)</td><td>0</td><td>0</td><td>0</td><td>0</td><td>1</td><td>1</td><td>1</td><td>1</td></tr> </table> |                  |                 | Value set in P793  | 0 | 1 | 2 | 3 | 4 | 5 | 6 | 7 | Relay (Bit 0) | 0 | 1 | 0 | 1 | 0 | 1 | 0 | 1 | TB14 (Bit 1) | 0 | 0 | 1 | 1 | 0 | 0 | 1 | 1 | I/O option Relay (Bit 2) | 0 | 0 | 0 | 0 | 1 | 1 | 1 | 1 | bit = 0: OFF (De-energized)<br>bit = 1: ON (Energized)<br>The corresponding digital output/relay must be set to accept data from the sequencer: P140, P142, P441 = 27 |
| Value set in P793        | 0  | 1                 | 2   | 3                | 4               | 5  | 6 | 7 |   |   |   |   |   |   |               |   |   |   |   |   |   |   |   |              |   |   |   |   |   |   |   |   |                          |   |   |   |   |   |   |   |   |   |
| Relay (Bit 0)            | 0  | 1                 | 0   | 1                | 0               | 1  | 0 | 1 |   |   |   |   |   |   |               |   |   |   |   |   |   |   |   |              |   |   |   |   |   |   |   |   |                          |   |   |   |   |   |   |   |   |   |
| TB14 (Bit 1)             | 0  | 0                 | 1   | 1                | 0               | 0  | 1 | 1 |   |   |   |   |   |   |               |   |   |   |   |   |   |   |   |              |   |   |   |   |   |   |   |   |                          |   |   |   |   |   |   |   |   |   |
| I/O option Relay (Bit 2) | 0  | 0                 | 0   | 0                | 1               | 1  | 1 | 1 |   |   |   |   |   |   |               |   |   |   |   |   |   |   |   |              |   |   |   |   |   |   |   |   |                          |   |   |   |   |   |   |   |   |   |



## Commissioning

| Code |                                       | Possible Settings |  |             | IMPORTANT   |
|------|---------------------------------------|-------------------|--|-------------|---|
| No.  | Name                                  | Default           | Selection  |             |   |
| P794 | End Segment: TB30 Analog Output Value | 0.00              | 0.00   | (VDC) 10.00 | TB30 configuration parameter must be set to accept this value: P150 = 10                                      |
| P795 | End Segment: Drive Action             | 0                 | 0 Keep Running<br>1 Stop (based on P111)<br>2 Coast to Stop<br>3 Quick Stop (per P127)<br>4 Coast with DC Brake<br>5 Ramp with DC Brake  |             | Recovery: Toggling the START SEQUENCE will start the cycle from 'end segment Stop' or 'end segment DC Brake'. |
|      |                                       |                   | <b>WARNING!</b><br>If P795 = 0 then toggling the start sequence input will also restart the sequencer cycle but in the interim where TB13X is open the drive will ramp to the standard or specified alternate speed source depending on the drive configuration. |             |   |



### WARNING

If the input defined to "Start Sequence" is opened during a sequence, the drive will exit sequencer mode and will run at the specified standard or alternate speed source (dependent on drive configuration).

# Commissioning



## 4.5.9.1 Sequencer Flow Diagram Left

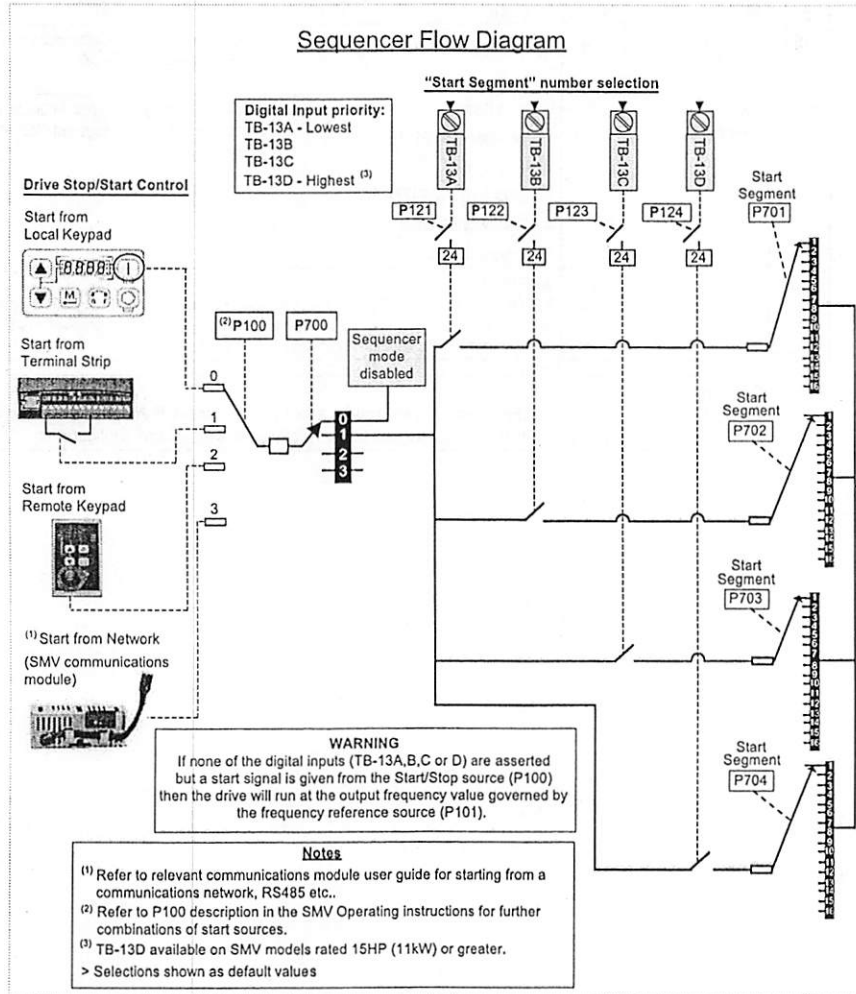

**WARNING**

If the input defined to "Start Sequence" is opened during a sequence, the drive will exit sequencer mode and will run at the specified standard or alternate speed source (dependent on drive configuration).



# Commissioning

## 4.5.9.2 Sequencer Flow Diagram Right

| Action after Stop/Start (P100) transition/digital input (if setup for sequencer mode) transition or restart after trip. |   |
|---|---|
| P706  | Action  |
| 0   | Restart at beginning of sequence (pointed by TB13x) |
| 1   | Restart at beginning of current segment             |
| 2   | Start at beginning of prior segment                 |
| 3   | Start at beginning of next segment                  |

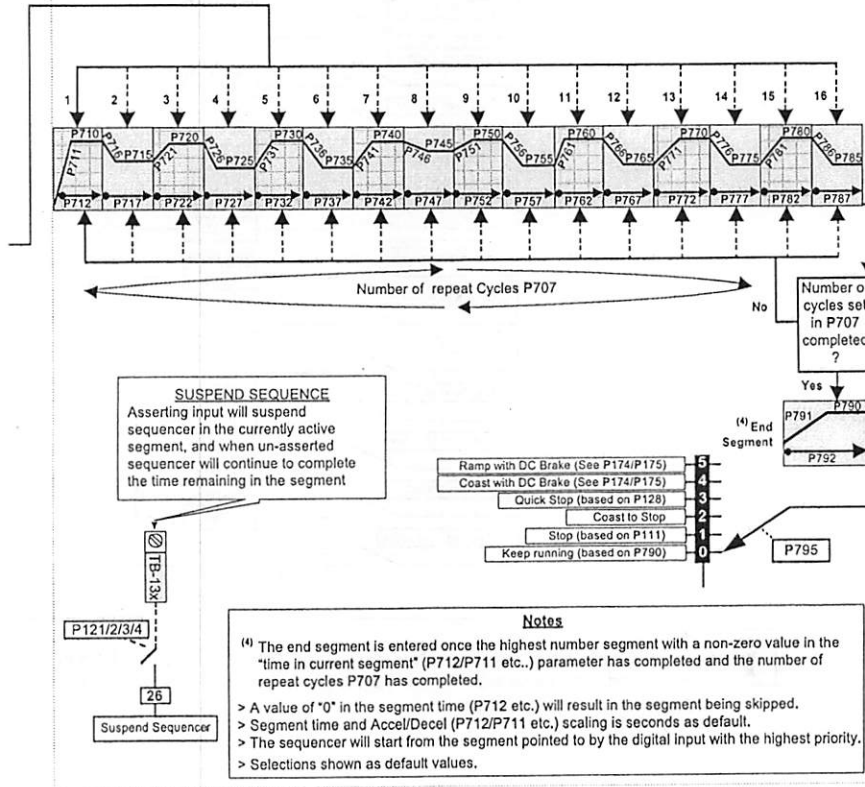

## Commissioning



### 4.5.9.3 Sequencer Status

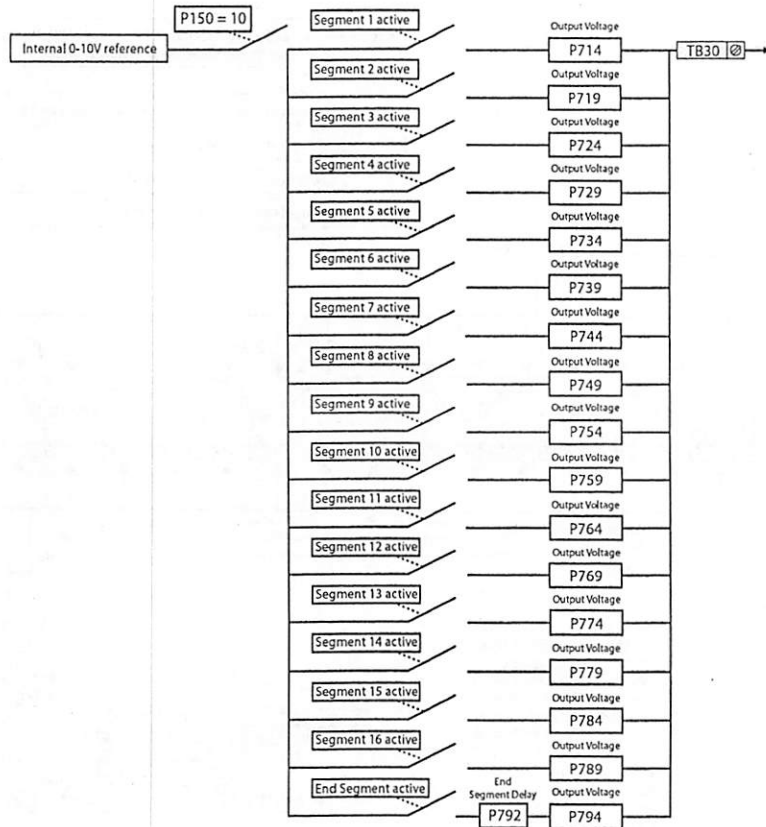

**NOTE**

On the "End Segment", the output voltage is not present until after the end segment delay P792 has expired. On the other segments the output voltage is present on entry to the segment. The same is true for the digital outputs.

(1) The drive can only be restarted if the error message has been reset.





## Troubleshooting and Diagnostics

### 5 Troubleshooting and Diagnostics

#### 5.1 Status/Warning Messages

| Status / Warning  | Cause   | Remedy  |
|---|---|---|
| <b>br</b> DC-injection brake active   | DC-injection brake activated <ul style="list-style-type: none"> <li>• activation of digital input (P121...P124 = 18)</li> <li>• automatically (P110 = 2, 4...6)</li> <li>• automatically (P111 = 1, 3)</li> </ul> | Deactivate DC-injection brake <ul style="list-style-type: none"> <li>• deactivate digital input</li> <li>• automatically after P175 time has expired</li> </ul>   |
| <b>bF</b> Drive ID warning  | The Drive ID (P502) stored on the EPM does not match the drive model.   | <ul style="list-style-type: none"> <li>• Verify motor data (P302...P306) and perform Auto Calibration.</li> <li>• Set drive mode (P300) to 0 or 1</li> <li>• Reset the drive (P199 to 3 or 4) and reprogram.</li> </ul> |
| <b>CAL</b> Motor Auto-calibration active  | Refer to P300, P399   | Motor Auto-calibration is being performed   |
| <b>cE</b> An EPM that contains valid data from a previous software version has been installed | An attempt was made to change parameter settings  | Parameter settings can only be changed after the EPM data is converted to the current version (P199 = 5)  |
| <b>CL</b> Current Limit (P171) reached  | Motor overload  | <ul style="list-style-type: none"> <li>• Increase P171</li> <li>• Verify drive/motor are proper size for application</li> </ul>   |
| <b>dEC</b> Decel Override   | The drive has stopped decelerating to avoid tripping into HF fault, due to excessive motor regen (2 sec max).   | If drive trips into HF fault: <ul style="list-style-type: none"> <li>• Increase P105, P126</li> <li>• Install Dynamic Braking option</li> </ul>   |
| <b>Err</b> Error  | Invalid data was entered, or an invalid command was attempted   |   |
| <b>FCL</b> Fast Current Limit   | Overload  | Verify drive/motor are proper size for application  |
| <b>FSE</b> Flying Restart Attempt after Fault   | P110 = 5,6  |   |
| <b>GE</b> OEM Settings Operation warning  | An attempt was made to change parameter settings while the drive is operating in OEM Settings mode.   | In OEM Settings mode (P199 = 1), making changes to parameters is not permitted.   |
| <b>GF</b> OEM Defaults data warning   | An attempt was made to use (or reset to) the OEM default settings (P199 = 1 or 2) using an EPM without valid OEM data.  | Install an EPM containing valid OEM Defaults data   |
| <b>LC</b> Fault Lockout   | The drive attempted 5 restarts after a fault but all attempts were unsuccessful (P110 = 3...6)  | <ul style="list-style-type: none"> <li>• Drive requires manual reset</li> <li>• Check Fault History (P500) and correct fault condition</li> </ul>   |
| <b>PdEC</b> PID Deceleration Status   | PID setpoint has finished its ramp but the drive is still decelerating to a stop.   |   |
| <b>PI d</b> PID Mode Active   | Drive has been put into PID Mode.   | Refer to P200   |
| <b>SLP</b> Sleep Mode is active   | Refer to P240...P242  |   |
| <b>SP</b> Start Pending   | The drive has tripped into a fault and will automatically restart (P110 = 3...6)  | To disable Auto-Restart, set P110 = 0...2   |
| <b>SPd</b> PID Mode disabled.   | Drive has been taken out of PID Mode. Refer to P200.  |   |
| <b>StoP</b> Output frequency = 0 Hz (outputs U, V, W inhibited)                               | Stop has been commanded from the keypad, terminal strip, or network   | Apply Start command (Start Control source depends on P100)  |

(1) The drive can only be restarted if the error message has been reset.

## Troubleshooting and Diagnostics



### 5.2 Drive Configuration Messages

When the Mode button is pressed and held, the drive's display will provide a 4-digit code that indicates how the drive is configured. If the drive is in a Stop state when this is done, the display will also indicate which control source commanded the drive to Stop (the two displays will alternate every second).

| Configuration Display   |  |   |  |
|---|--|---|--|
| Format = x.y.zz   | <b>x = Control Source:</b><br>L = Local Keypad<br>t = Terminal Strip<br>r = Remote Keypad<br>n = Network   | <b>y = Mode:</b><br>S = Speed mode<br>P = PID mode<br>t = Torque mode<br>C = Sequencer mode | <b>zz = Reference:</b><br>CP = Keypad ▲ ▼<br>EU = 0-10 VDC (TB-5)<br>E I = 4-20 mA (TB-25)<br>JG = Jog<br>nE = Network<br>OP = MOP<br>P L...P7 = Preset 1...7<br>O L... I6 = Sequencer Segment |
| Example:<br>L_S_CP = Local Keypad Start control, Speed mode, Keypad speed reference<br>t_P_EU = Terminal Strip Start control, PID mode, 0-10 VDC setpoint reference<br>t_C_I2 = Terminal Strip Start control, Sequencer Operation (Speed mode), Segment #12<br>n_t_P2 = Network Start control, Vector Torque mode, Preset Torque #2 reference<br>n_S_O3 = Network Start control, Speed mode, Speed reference from Sequencer segment #03 |  |   |  |
| Stop Source Display   |  |   |  |
| Format = x_S tP   | L_S tP = Stop command came from Local Keypad<br>t_S tP = Stop command came from Terminal Strip<br>r_S tP = Stop command came from Remote Keypad<br>n_S tP = Stop command came from Network |   |  |

### 5.3 Fault Messages

The messages below show how they will appear on the display when the drive trips. When looking at the Fault History (P500), the F\_ will not appear in the fault message.

| Fault | Cause   | Remedy <sup>(1)</sup>   |
|-------|---|---|
| F_FF  | High Temperature fault<br>Drive is too hot inside   | <ul style="list-style-type: none"> <li>• Reduce drive load</li> <li>• Improve cooling</li> </ul>  |
| F_AL  | Assertion Level fault <ul style="list-style-type: none"> <li>• Assertion Level switch is changed during operation</li> <li>• P120 is changed during operation</li> <li>• P100 or P121...P124 are set to a value other than 0 and P120 does not match the Assertion Level Switch.</li> </ul> | <ul style="list-style-type: none"> <li>• Make sure the Assertion Level switch and P120 are both set for the type of input devices being used, prior to setting P100 or P121...P124.</li> <li>• Refer to 3.2.3 and P120.</li> </ul>                                    |
| F_bF  | Personality fault<br>Drive Hardware   | <ul style="list-style-type: none"> <li>• Cycle Power</li> <li>• Power down and install EPM with valid data</li> <li>• Reset the drive back to defaults (P199 = 3, 4) and then re-program</li> <li>• If problem persists, contact factory technical support</li> </ul> |
| F_cF  | Control fault<br>An EPM has been installed that is either blank or corrupted  |   |
| F_cF  | Incompatible EPM fault<br>An EPM has been installed that contains data from an incompatible parameter version   |   |
| F_cFt | Forced Translation fault<br>An EPM from an old drive put in new drive causes drive to trip F_cFT fault.   | Press [M] (mode button) twice to reset  |



## Troubleshooting and Diagnostics

| Fault                 | Cause   | Remedy <sup>(1)</sup>  |  |
|-----------------------|---|--|--|
| F_dbF                 | Dynamic Braking fault                           | Dynamic braking resistors are overheating  | <ul style="list-style-type: none"> <li>Increase active decel time (P105, P126, P127).</li> <li>Check mains voltage and P107</li> </ul>                       |
| F_EF                  | External fault                                  | <ul style="list-style-type: none"> <li>P121...P124 = 21 and that digital input has been opened.</li> <li>P121...P124 = 22 and that digital input has been closed.</li> </ul> | <ul style="list-style-type: none"> <li>Correct the external fault condition</li> <li>Make sure digital input is set properly for NC or NO circuit</li> </ul> |
| F_F1                  | EPM fault                                       | EPM missing or defective   | Power down and replace EPM   |
| F_F2<br>...<br>F_F12  | Internal faults                                 |  | Contact factory technical support  |
| F_FnF                 | Control Configuration Fault                     | The drive is setup for REMOTE KEYPAD control (P100=2 or 5) but is not setup to communicate with a remote keypad  | Set P400 = 1, or P600 = 1  |
|                       |   | The drive is setup for NETWORK ONLY control (P100=3) but is not setup for network communications   | Set P400 or P600 to a valid network communications protocol selection  |
| F_FoL                 | TB25 (4-20 mA signal) Threshold fault           | 4-20 mA signal (at TB-25) drops below the value set in P164.   | <ul style="list-style-type: none"> <li>Check signal/signal wire</li> <li>Refer to parameters P163 and P164.</li> </ul>                                       |
| F_GF                  | OEM Defaults data fault                         | Drive is powered up with P199 = 1 and OEM settings in the EPM are not valid.   | Install an EPM containing valid OEM Defaults data or change P199 to 0.   |
| F_HF                  | High DC Bus Voltage fault                       | Mains voltage is too high  | Check mains voltage and P107   |
|                       |   | Decel time is too short, or too much regen from motor  | Increase active decel time (P105, P126, P127) or install Dynamic Braking option  |
| F_IL                  | Digital Input Configuration fault (P121...P124) | More than one digital input set for the same function  | Each setting can only be used once (except settings 0 and 3)   |
|                       |   | Only one digital input configured for MOP function (Up, Down)  | One input must be set to MOP Up, another must be set to MOP Down   |
|                       |   | PID mode is entered with setpoint reference and feedback source set to the same analog signal  | Change PID setpoint reference (P121...P124) or feedback source (P201).   |
|                       |   | One of the digital inputs (P121...P124) is set to 10 and another is set to 11...14.  | Reconfigure digital inputs   |
|                       |   | One of the digital inputs (P121...P124) is set to 11 or 12 and another is set to 13 or 14.   |  |
|                       |   | PID enabled in Vector Torque mode (P200 = 1 or 2 and P300 = 5)   | PID cannot be used in Vector Torque mode   |
| F_JF                  | Remote keypad fault                             | Remote keypad disconnected   | Check remote keypad connections  |
| F_LF                  | Low DC Bus Voltage fault                        | Mains voltage too low  | Check mains voltage  |
| F_nId                 | No Motor ID fault                               | An attempt was made to start the drive in Vector or Enhanced V/Hz mode prior to performing the Motor Auto-calibration  | Refer to parameters P300...P399 for Drive Mode setup and calibration.  |
| F_nLF                 | Module communication fault                      | Communication failure between drive and Network Module.  | Check module connections   |
| F_nF1<br>...<br>F_nF9 | Network Faults                                  | Refer to the module documentation, for Causes and Remedies.  |  |

## Troubleshooting and Diagnostics



| Fault |                                    | Cause   | Remedy <sup>(1)</sup>  |
|-------|------------------------------------|---|--|
| F_QF  | Output fault:<br>Transistor fault  | Output short circuit  | Check motor/motor cable  |
|       |                                    | Acceleration time too short   | Increase P104, P125  |
|       |                                    | Severe motor overload, due to:<br>• Mechanical problem<br>• Drive/motor too small for application | <ul style="list-style-type: none"> <li>• Check machine / system</li> <li>• Verify drive/motor are proper size for application</li> </ul>   |
|       |                                    | Boost values too high   | Decrease P168, P169  |
|       |                                    | Excessive capacitive charging current of the motor cable  | <ul style="list-style-type: none"> <li>• Use shorter motor cables with lower charging current</li> <li>• Use low capacitance motor cables</li> <li>• Install reactor between motor and drive.</li> </ul> |
|       |                                    | Failed output transistor  | Contact factory technical support  |
| F_QFI | Output fault: Ground fault         | Grounded motor phase  | Check motor and motor cable  |
|       |                                    | Excessive capacitive charging current of the motor cable  | Use shorter motor cables with lower charging current   |
| F_PF  | Motor Overload fault               | Excessive motor load for too long   | <ul style="list-style-type: none"> <li>• Verify proper setting of P108</li> <li>• Verify drive and motor are proper size for application</li> </ul>  |
| F_rF  | Flying Restart fault               | Controller was unable to synchronize with the motor during restart attempt; (P110 = 5 or 6)       | Check motor / load   |
| F_SF  | Single-Phase fault                 | A mains phase has been lost   | Check mains voltage  |
| F_UF  | Start fault                        | Start command was present when power was applied (P110 = 0 or 2).                                 | <ul style="list-style-type: none"> <li>• Must wait at least 2 seconds after power-up to apply Start command</li> <li>• Consider alternate starting method (P110).</li> </ul>                             |
| F_FRU | TB5 (0-10V signal) Threshold fault | 0-10V signal (at TB5) drops below the value set in P158.  | <ul style="list-style-type: none"> <li>• Check signal/signal wire</li> <li>• Refer to parameters P157 and P158</li> </ul>  |

(1) The drive can only be restarted if the error message has been reset.



## Appendix

### Appendix A

#### A.1 Permissible Cable Lengths

The table herein lists the permissible cable lengths for use with an SMV inverter with an internal EMC filter.



##### NOTE

This table is intended as a reference guideline only; application results may vary. The values in this table are based on testing with commonly available low-capacitance shielded cable and commonly available AC induction motors. Testing is conducted at worst case speeds and loads.

| Maximum Permissible Cable Lengths (Meters) for SMV Model with Internal EMC Filters |                                 |                             |         |                             |         |                             |         |                              |         |
|--|---------------------------------|-----------------------------|---------|-----------------------------|---------|-----------------------------|---------|------------------------------|---------|
| Mains  | Model                           | 4 kHz Carrier<br>(P166 = 0) |         | 6 kHz Carrier<br>(P166 = 1) |         | 8 kHz Carrier<br>(P166 = 2) |         | 10 kHz Carrier<br>(P166 = 3) |         |
|  |                                 | Class A                     | Class B | Class A                     | Class B | Class A                     | Class B | Class A                      | Class B |
| 240 V, 1-phase<br>(2/PE)   | ESV251 $\phi$ $\phi$ 2SF $\phi$ | 38                          | 12      | 35                          | 10      | 33                          | 5       | 30                           | N/A     |
|  | ESV371 $\phi$ $\phi$ 2SF $\phi$ | 38                          | 12      | 35                          | 10      | 33                          | 5       | 30                           | N/A     |
|  | ESV751 $\phi$ $\phi$ 2SF $\phi$ | 38                          | 12      | 35                          | 10      | 33                          | 5       | 30                           | N/A     |
|  | ESV112 $\phi$ $\phi$ 2SF $\phi$ | 38                          | 12      | 35                          | 10      | 33                          | 5       | 30                           | N/A     |
|  | ESV152 $\phi$ $\phi$ 2SF $\phi$ | 38                          | 12      | 35                          | 10      | 33                          | 5       | 30                           | N/A     |
|  | ESV222 $\phi$ $\phi$ 2SF $\phi$ | 38                          | 12      | 35                          | 10      | 33                          | 5       | 30                           | N/A     |
| 400/480 V, 3-phase<br>(3/PE)   | ESV371 $\phi$ $\phi$ 4TF $\phi$ | 30                          | 4       | 25                          | 2       | 20                          | N/A     | 10                           | N/A     |
|  | ESV751 $\phi$ $\phi$ 4TF $\phi$ | 30                          | 4       | 25                          | 2       | 20                          | N/A     | 10                           | N/A     |
|  | ESV112 $\phi$ $\phi$ 4TF $\phi$ | 30                          | 4       | 25                          | 2       | 20                          | N/A     | 10                           | N/A     |
|  | ESV152 $\phi$ $\phi$ 4TF $\phi$ | 30                          | 4       | 25                          | 2       | 20                          | N/A     | 10                           | N/A     |
|  | ESV222 $\phi$ $\phi$ 4TF $\phi$ | 30                          | 4       | 25                          | 2       | 20                          | N/A     | 10                           | N/A     |
|  | ESV302 $\phi$ $\phi$ 4TF $\phi$ | 30                          | 4       | 25                          | 2       | 20                          | N/A     | 10                           | N/A     |
|  | ESV402 $\phi$ $\phi$ 4TF $\phi$ | 54                          | 5       | 48                          | 3       | 42                          | 2       | N/A                          | N/A     |
|  | ESV552 $\phi$ $\phi$ 4TF $\phi$ | 54                          | 5       | 48                          | 3       | 42                          | 2       | N/A                          | N/A     |
| ESV752 $\phi$ $\phi$ 4TF $\phi$  | 54                              | 5                           | 48      | 3                           | 42      | 2                           | N/A     | N/A                          |         |

NOTE: The " $\phi$ " and " $\phi$ " symbols are place holders in the Model part number that contain different information depending on the specific configuration of the model. Refer to the SMV Type Number Designation table in section 2.2 for more information.

Lenze SMVector 13465100 ED8SV01 EN v18



## AquaMark Boosters

245 W. Roosevelt Road  
Building 12, Suite 83  
West Chicago, IL 60185



800-323-4498



888-246-5725



[info@aquamarkboosters.com](mailto:info@aquamarkboosters.com)



[www.aquamarkboosters.com](http://www.aquamarkboosters.com)

## TWO YEAR LIMITED WARRANTY

H.O.K. Sales, Incorporated/AquaMark (referred to as Manufacturer hereinafter) warrants all of its pressure boosting systems (Product) for two years from date of purchase, to be free of defects in materials and workmanship, provided they are installed in accordance with factory specifications (as specified in the "INSTALLATION, OPERATION & MAINTENANCE manual") for each individual system.

This warranty applies to the original purchaser (referred to as Purchaser hereinafter) and subsequent owners. By accepting and keeping this product Purchaser agrees to all the warranty terms and limitations of liability described herein. Manufacturer warrants only to original installation location and only when installed, operated and maintained in accordance with printed instructions accompanying the Product.

All claims must be made within the two (2) year warranty time period measured from the time the Product was purchased.

All warranty claims will be handled as follows: Any defect in material or workmanship will be repaired or, at Manufacturer's option, corrected with new or used replacement parts, or Products, at Manufacturers expense. If after a reasonable number of attempts to remedy the problem, it cannot be repaired so the product will conform to this warranty, a new replacement component or entire Product will be supplied, at the Manufacturer's option. Under no circumstance will any claims for more than the original cost of the Product be accepted, including labor.

This warranty does not cover any failure or problem unless it is caused by a defect in material or workmanship and in addition shall not apply to the following:

- If the product is not correctly installed, operated, repaired, and or maintained as described in the INSTALLATION, OPERATION, & MAINTANANCE manual.
- If any failure or malfunction results from abuse, i.e., freezing, improper or negligent handling, shipping, storage, accident, lightning, flood or environmental conditions.
- If the product is used outside the U.S.A.
- Warranty does not cover any labor costs, shipping and delivery expenses, administrative fees or any costs related to removing or reinstalling the Product.
- If any repair and/or replacement costs are not authorized by Manufacturer or authorized representatives in advance.

Each system has specific electrical and unrestricted piping supply size requirements and they are critical to the application of the one year warranty. See INSTALLATION, OPERATION & MAINTENANCE manual for details.

The remedies in the Warranty are the Purchaser's exclusive remedies. In no circumstances will the Manufacturer or its authorized representatives be liable for more than, and the Purchasers remedies shall not exceed, the price paid for the Product. In no case, shall the Manufacturer or it's authorized representatives be liable for any special damage to property, loss of profits, loss of savings or revenue, loss of use of the Product or any associated equipment, facilities, building or services, downtime, and claims of third parties including customers.

Any covered Warranty service must be authorized by the Manufacturer. Contact the person from whom you purchased the Product, who must receive authorization from the Manufacturer. Before the Manufacturer or an authorized representative determines to provide any replacement parts or Product, it may as a pre-condition to making such a determination, required that the Warranty claimant ship the Product, postage prepaid, to the Manufacturer or an authorized Manufacturer's representative and provide proof of purchase evidenced by the original sales receipt.

In case of replacement of a Product or any component part, the Manufacturer reserves the right to make changes in the design, construction, or material of the substitute components or Products, which shall be subject to all the terms and limitations of the Warranty, except that the applicable warranty period shall be reduced by the amount of time the warranty claimant owned the Product prior to submitting notification of the warranty claim.

### **AquaMark**

245 West Roosevelt Road, Building 12, Suite 83

West Chicago, IL 60185

Tel: (800) 323-4498

Fax: (888) 246-5725